

# Panasonic®

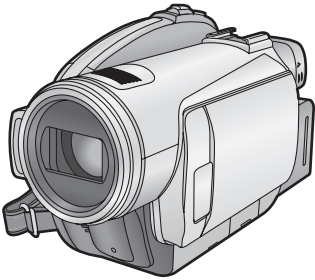

## Operating Instructions High Definition Video Camera

Model No. **HDC-SX5P/PC**

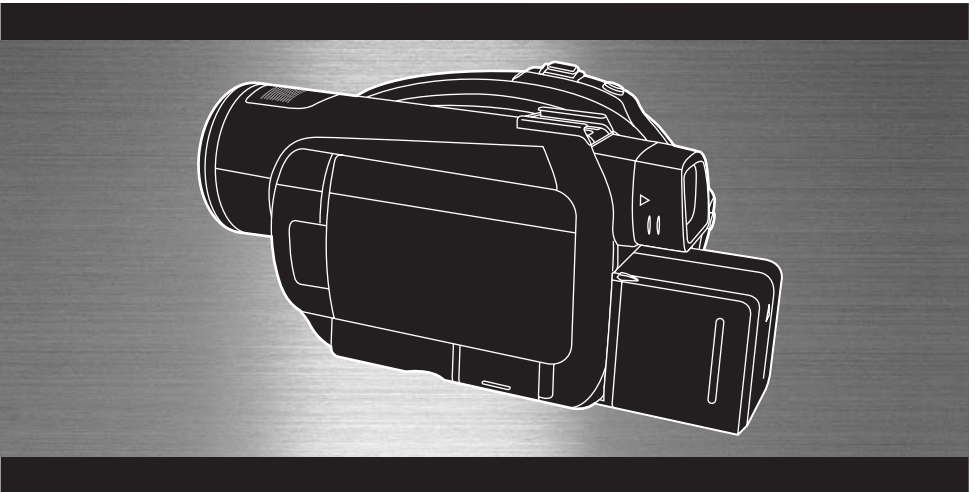

Before connecting, operating or adjusting this product, please read the instructions completely.  
Spanish Quick Use Guide is included.

Guía para rápida consulta en español está incluida.

**AVCHD**



**HDMI™**  
HIGH-DEFINITION MULTIMEDIA INTERFACE



**LEICA**  
DICOMAR

For USA assistance, please call: 1-800-211-PANA(7262) or, contact us via the web at: <http://www.panasonic.com/contactinfo>

For Canadian assistance, please call: 1-800-561-5505 or visit us at [www.panasonic.ca](http://www.panasonic.ca)

VQT1J42

## Things You Should Know

### Thank you for choosing Panasonic!

You have purchased one of the most sophisticated and reliable products on the market today. Used properly, we're sure it will bring you and your family years of enjoyment. Please take time to fill in the information on the right.

The serial number is on the tag located on the underside of your camera. Be sure to **retain this manual** as your convenient camera information source.

Date of Purchase	_____
Dealer Purchased From	_____
Dealer Address	_____
Dealer Phone No.	_____
Model No.	_____
Serial No.	_____

## Safety Precautions

### WARNING:

TO REDUCE THE RISK OF FIRE, ELECTRIC SHOCK OR PRODUCT DAMAGE,





- DO NOT EXPOSE THIS APPARATUS TO RAIN, MOISTURE, DRIPPING OR SPLASHING AND THAT NO OBJECTS FILLED WITH LIQUIDS, SUCH AS VASES, SHALL BE PLACED ON THE APPARATUS.
- USE ONLY THE RECOMMENDED ACCESSORIES.
- DO NOT REMOVE THE COVER (OR BACK); THERE ARE NO USER SERVICEABLE PARTS INSIDE. REFER SERVICING TO QUALIFIED SERVICE PERSONNEL.

### CAUTION!

DO NOT INSTALL OR PLACE THIS UNIT IN A BOOKCASE, BUILT-IN CABINET OR IN ANOTHER CONFINED SPACE. ENSURE THE UNIT IS WELL VENTILATED. TO PREVENT RISK OF ELECTRIC SHOCK OR FIRE HAZARD DUE TO OVERHEATING, ENSURE THAT CURTAINS AND ANY OTHER MATERIALS DO NOT OBSTRUCT THE VENTILATION VENTS.

The socket outlet shall be installed near the equipment and easily accessible. The mains plug of the power supply cord shall remain readily operable. To completely disconnect this apparatus from the AC Mains, disconnect the power supply cord plug from AC receptacle.

The following mark and symbols are located on bottom of the unit.

  		The lightning flash with arrowhead symbol, within an equilateral triangle, is intended to alert the user to the presence of uninsulated "dangerous voltage" within the product's enclosure that may be of sufficient magnitude to constitute a risk of electric shock to persons.
CAUTION: TO REDUCE THE RISK OF ELECTRIC SHOCK, DO NOT REMOVE SCREWS. NO USER-SERVICEABLE PARTS INSIDE. REFER SERVICING TO QUALIFIED SERVICE PERSONNEL.		The exclamation point within an equilateral triangle is intended to alert the user to the presence of important operating and maintenance (servicing) instructions in the literature accompanying the appliance.

**CLASS 1  
LASER PRODUCT**

IEC 60825-1:2001

**CAUTION**

This product contains a laser diode of higher class than 1.

To ensure continued safety, do not remove any covers or attempt to gain access to the inside of the product. Refer all servicing to qualified personnel.

**THE FOLLOWING APPLIES ONLY IN THE U.S.A.**

**FCC Note:**

This equipment has been tested and found to comply with the limits for a Class B digital device, pursuant to Part 15 of the FCC Rules. These limits are designed to provide reasonable protection against harmful interference in a residential installation. This equipment generates, uses, and can radiate radio frequency energy and, if not installed and used in accordance with the instructions, may cause harmful interference to radio communications. However, there is no guarantee that interference will not occur in a particular installation. If this equipment does cause harmful interference to radio or television reception, which can be determined by turning the equipment off and on, the user is encouraged to try to correct the interference by one or more of the following measures:

- Reorient or relocate the receiving antenna.
- Increase the separation between the equipment and receiver.
- Connect the equipment into an outlet on a circuit different from that to which the receiver is connected.
- Consult the dealer or an experienced radio/TV technician for help.

**FCC Caution:** To assure continued compliance, follow the attached installation instructions and use only shielded interface cables with ferrite core when connecting to computer or peripheral devices.

Any changes or modifications not expressly approved by the party responsible for compliance could void the user's authority to operate this equipment.

**Declaration of Conformity**

**Trade Name:** Panasonic  
**Model No.:** HDC-SX5P  
**Responsible party:** Panasonic Corporation of North America  
One Panasonic Way, Secaucus, NJ 07094  
**Support Contact:** Panasonic Consumer Electronics Company  
1-800-211-PANA (7262)

This device complies with Part 15 of the FCC Rules. Operation is subject to the following two conditions: (1) This device may not cause harmful interference, and (2) this device must accept any interference received, including interference that may cause undesired operation.



**THE FOLLOWING APPLIES ONLY IN CANADA.**

This Class B digital apparatus complies with Canadian ICES-003.

## Batteries

### 1 Battery pack (Lithium ion battery pack)

- Use the specified unit to recharge the battery pack.
- Do not use the battery pack with equipment other than the specified unit.
- Do not get dirt, sand, liquids, or other foreign matter on the terminals.
- Do not touch the plug terminals (+ and –) with metal objects.
- Do not disassemble, remodel, heat or throw into fire.

### 2 Button-type battery (Lithium battery)

- Insert with poles aligned.
- Do not touch the terminals (+ and –) with metal objects.
- Do not recharge, disassemble, remodel, heat or throw into fire.
- Keep out of reach of children

If any electrolyte should come into contact with your hands or clothes, wash it off thoroughly with water.

If any electrolyte should come into contact with your eyes, never rub the eyes. Rinse eyes thoroughly with water, and then consult a doctor.

## Warning

Risk of fire, explosion and burns. Do not disassemble.

Do not heat the batteries above the following temperatures or incinerate.

**Button-type battery** 60 °C (140 °F)

**Battery pack** 60 °C (140 °F)

## AC adaptor

This AC adaptor operates on AC between 110 V and 240 V.

But

- In the U.S.A. and Canada, the AC adaptor must be connected to a 120V AC power supply only.
- When connecting to an AC supply outside of the U.S.A. or Canada, use a plug adaptor to suit the AC outlet configuration.
- When connecting to a supply of greater than AC 125V, ensure the cord you use is suited to the voltage of the AC supply and the rated current of the AC adaptor.
- Contact an electrical parts distributor for assistance in selecting a suitable AC plug adaptor or AC cord set.

Product Identification Marking is located on the bottom of units.

## U.S.A./CANADA CONSUMERS: ATTENTION:



A lithium ion/polymer battery that is recyclable powers the product you have purchased. Please call 1-800-8-BATTERY for information on how to recycle this battery.

### <For USA-California only>

This product contains a CR Coin Cell Lithium Battery which contains Perchlorate Material – special handling may apply.

See [www.dtsc.ca.gov/hazardouswaste/perchlorate](http://www.dtsc.ca.gov/hazardouswaste/perchlorate).

---

# IMPORTANT SAFETY INSTRUCTIONS

Read these operating instructions carefully before using the unit. Follow the safety instructions on the unit and the applicable safety instructions listed below. Keep these operating instructions handy for future reference.

- 1) Read these instructions.
- 2) Keep these instructions.
- 3) Heed all warnings.
- 4) Follow all instructions.
- 5) Do not use this apparatus near water.
- 6) Clean only with dry cloth.
- 7) Do not block any ventilation openings. Install in accordance with the manufacturer's instructions.
- 8) Do not install near any heat sources such as radiators, heat registers, stoves, or other apparatus (including amplifiers) that produce heat.
- 9) Do not defeat the safety purpose of the polarized or grounding-type plug. A polarized plug has two blades with one wider than the other. A grounding-type plug has two blades and a third grounding prong. The wide blade or the third prong are provided for your safety. If the provided plug does not fit into your outlet, consult an electrician for replacement of the obsolete outlet.
- 10) Protect the power cord from being walked on or pinched particularly at plugs, convenience receptacles, and the point where they exit from the apparatus.
- 11) Only use attachments/accessories specified by the manufacturer.
- 12) Use only with the cart, stand, tripod, bracket, or the table specified by the manufacturer, or sold with the apparatus. When a cart is used, use caution when moving the cart/apparatus combination to avoid injury from tip-over.
- 13) Unplug this apparatus during lightning storms or when unused for long periods of time.
- 14) Refer all servicing to qualified service personnel. Servicing is required when the apparatus has been damaged in any way, such as power-supply cord or plug is damaged, liquid has been spilled or objects have fallen into the apparatus, the apparatus has been exposed to rain or moisture, does not operate normally, or has been dropped.



## Precautions

### USE & LOCATION

#### **WARNING**

- **TO AVOID SHOCK HAZARD ...** Your camera and power supply should not be exposed to rain or moisture. Do not connect the power supply or operate your camera if it gets wet. Your camera has been designed for outdoor use, however it is not designed to sustain direct exposure to water, rain, sleet, snow, sand, dust, or a direct splashing from a pool or even a cup of coffee. This action could permanently damage the internal parts of your camera. Do not attempt to disassemble this unit. There are no user serviceable parts inside. Unplug your camera from the power supply before cleaning.
- **AS WITH ANY SMALL OBJECT, SD CARDS CAN BE SWALLOWED BY YOUNG CHILDREN. DO NOT ALLOW CHILDREN TO HANDLE THE SD CARD.**

#### **CAUTION**

- **DO NOT AIM YOUR CAMERA AT THE SUN OR OTHER BRIGHT OBJECTS**
- **DO NOT LEAVE THE CAMERA WITH THE EVF AIMED DIRECTLY AT THE SUN AS THIS MAY CAUSE DAMAGE TO THE INTERNAL PARTS OF THE EVF**
- **DO NOT EXPOSE YOUR CAMERA TO EXTENDED HIGH TEMPERATURE ...** Such as, in direct sunlight, inside a closed car, next to a heater, etc... This action could permanently damage the internal parts of your camera.
- **AVOID SUDDEN CHANGES IN TEMPERATURE ...** If the unit is suddenly moved from a cold place to a warm place, moisture may form on the disc and inside the unit.
- **DO NOT LEAVE YOUR CAMERA OR THE POWER SUPPLY TURNED ON WHEN NOT IN USE.**
- **STORAGE OF YOUR CAMERA ...** Store and handle your camera in a manner that will not subject it to unnecessary movement (avoid shaking and striking). Your camera contains a sensitive pick-up device which could be damaged by improper handling or storage.

## CARE

- **TO CLEAN YOUR CAMERA ...** Do not use strong or abrasive detergents when cleaning your camera body.
- **TO PROTECT THE LENS ...** Do not touch the surface of the lens with your hand. Use a commercial camera lens solution and lens paper when cleaning the lens. Improper cleaning can scratch the lens coating.
- **TO PROTECT THE FINISH OF YOUR CAMERA ...** Before handling your camera, make sure your hands and face are free from any chemical products, such as suntan lotion, as it may damage the finish.

### -If you see this symbol-

#### Information on Disposal in other Countries outside the European Union



This symbol is only valid in the European Union. If you wish to discard this product, please contact your local authorities or dealer and ask for the correct method of disposal.

---

## ■ Indemnity concerning recording content

The manufacturer shall in no event be liable for the loss of recordings due to malfunction or defect of this unit, its accessories or recordable media.

## IMPORTANT

### ■ Carefully observe copyright laws

**Whatever you have recorded and created can be used for your personal entertainment only. Under copyright laws, other materials cannot be used without obtaining permission from the holders of the copyrights.**

- SDHC Logo is a trademark.
- miniSD Logo is a trademark.
- “AVCHD” and the “AVCHD” Logo are the trademarks of Matsushita Electric Industrial Co., Ltd. and the Sony Corporation.
- Manufactured under license from Dolby Laboratories.  
Dolby and the double-D symbol are trademarks of Dolby Laboratories.
- HDMI, the HDMI Logo and the High-Definition Multimedia Interface are the registered trademarks or trademarks of HDMI Licensing LLC.
- HDAVI Control™ is a trademark of Matsushita Electric Industrial Co., Ltd.
- LEICA is a registered trademark of Leica Microsystems IR GmbH and DICOMAR is a registered trademark of Leica Camera AG.
- Microsoft®, Windows®, Windows Vista™ and DirectX® are either registered trademarks or trademarks of the Microsoft Corporation in the United States and/or other countries.
- IBM and PC/AT are registered trademarks of International Business Machines Corporation of the U.S.
- Intel®, Core™, Pentium® and Celeron® are the registered trademarks or trademarks of the Intel Corporation in the United States and other countries.
- Microsoft product screen shot(s) reprinted with permission from Microsoft Corporation.
- Other names of systems and products mentioned in these instructions are usually the registered trademarks or trademarks of the

manufacturers who developed the system or product concerned.

This product is licensed under the AVC patent portfolio license for the personal and non-commercial use of a consumer to (i) encode video in compliance with the AVC Standard (“AVC Video”) and/or (ii) decode AVC Video that was encoded by a consumer engaged in a personal and non-commercial activity and/or was obtained from a video provider licensed to provide AVC Video. No license is granted or shall be implied for any other use. Additional information may be obtained from MPEG LA, LLC. See <http://www.mpegla.com>.

## Contents

Accessories .....	10
Quick Guide .....	10

### Before using

Features of the High Definition Video Camera .....	14
Parts identification and handling .....	18
Using the LCD monitor .....	21
Using the viewfinder .....	22
Using the remote control .....	22
Discs that can be used on this unit .....	24
Cards that you can use with this unit .....	28
Disc and card handling .....	30

### Setup

Charging the battery .....	31
Inserting/Removing the battery .....	31
Charging and recording time .....	32
Connecting to the AC outlet .....	35
Selecting a mode (Turning the unit on/off) .....	36
Quick start .....	38
Inserting/removing a disc .....	39
Inserting/removing an SD card .....	40
How to use the cursor button .....	41
Language selection .....	46
Using the menu screen .....	47
Setting date and time .....	48
Adjusting LCD monitor/viewfinder .....	49

## Recording

Before recording .....	51
Recording motion pictures .....	53
PRE-REC function .....	55
Recording modes and recordable time available for the motion picture .....	56
Recording still pictures (JPEG images) on an SD card .....	58
Number of pixels and picture quality for still picture recording .....	60
Recording functions .....	61
Zoom in/out function .....	61
Recording Yourself .....	63
Intelligent contrast control .....	63
Fade in/fade out function .....	64
MagicPix function .....	65
Soft skin mode .....	65
Backlight compensation function .....	66
Self-timer recording .....	66
Built-in flash .....	67
Tele macro function .....	69
Image stabilizer function .....	69
Guide line function .....	70
Wind noise reduction function .....	71
Microphone level .....	71
Zebra display .....	72
Color bar .....	73
Auto slow shutter mode .....	73
Manual recording functions .....	74
Scene mode .....	74
Manual focus adjustment .....	75
White balance .....	76
Manual shutter speed/aperture adjustment .....	77

### Playback

Playback of motion pictures .....	79
Still picture playback (JPEG images) on an SD card .....	84



## Editing

<b>Editing scenes</b> .....	<b>86</b>
Deleting scenes .....	86
Dividing a scene to delete .....	87
Protecting scenes .....	88
<b>Copying from an SD card to a disc</b> ...	<b>89</b>
<b>Editing still pictures</b> .....	<b>90</b>
Deleting still pictures .....	90
Protecting still pictures .....	91
DPOF setting .....	92

## Disc and card management

<b>Formatting</b> .....	<b>93</b>
Formatting discs .....	93
Formatting SD cards .....	94
<b>Finalizing a disc</b> .....	<b>94</b>
Finalizing a disc .....	94
Un-finalizing a DVD-RW .....	96
Creating a top menu .....	96
<b>Protecting a disc</b> .....	<b>97</b>
<b>Disc protection setting</b> .....	<b>98</b>
<b>Displaying disc information</b> .....	<b>99</b>

## With other products

<b>Watching Video/Pictures on your TV</b> .....	<b>100</b>
Playback on TV .....	100
<b>1</b> Connecting with a HDMI cable (optional) .....	101
Playback using EZ Sync™ (HDAVI Control™) .....	103
<b>2</b> Connecting with the component cable (supplied) and the AV cable (supplied) .....	105
<b>3</b> Connecting with the AV cable (supplied) .....	106
<b>With Blu-ray Disc Player, DVD recorder, DVD player, computer etc.</b> .....	<b>108</b>
Playback using Blu-ray Disc Players .....	108
Playback on DVD recorder, DVD player, computer etc. ....	108
<b>With a DVD recorder or video device</b> .....	<b>109</b>
Dubbing images onto other video device .....	109
<b>With a printer (PictBridge)</b> .....	<b>110</b>

## With a computer

<b>Before using with a computer</b> .....	<b>112</b>
What you can do with a computer .....	112
Contents on provided CD-ROM .....	113
End User License Agreement .....	114
Operating environment .....	115
<b>Installation</b> .....	<b>117</b>
Installing HD Writer 2.0E for SX/SD .....	117
Reading the operating instructions of the software applications .....	118
Uninstalling software application .....	118
<b>Connection and recognition</b> .....	<b>119</b>
Camera-Computer connection .....	119
About the computer display .....	120
To disconnect USB cable safely .....	121
Verifying the unit is correctly recognized by the computer .....	122
<b>Using HD Writer 2.0E for SX/SD</b> .....	<b>123</b>
<b>If using a Macintosh</b> .....	<b>127</b>

## Others

<b>Menus and Indications</b> .....	<b>128</b>
Menu list .....	128
Indications .....	132
Messages .....	135
<b>Functions that cannot be used simultaneously</b> .....	<b>138</b>
<b>Frequently asked questions</b> .....	<b>139</b>
<b>Troubleshooting</b> .....	<b>140</b>
<b>Cautions for use</b> .....	<b>151</b>
<b>Explanation of terms</b> .....	<b>154</b>
<b>Specifications</b> .....	<b>156</b>
<b>Optional accessories</b> .....	<b>159</b>
<b>Accessory Order Form (For USA Customers)</b> .....	<b>161</b>
<b>Request for Service Notice (USA Only)</b> .....	<b>162</b>
<b>Limited Warranty (For USA Customers)</b> .....	<b>163</b>
<b>Customer Services Directory</b> .....	<b>164</b>
<b>Warranty (For Canadian Customers)</b> .....	<b>165</b>
<b>Index</b> .....	<b>166</b>
<b>Spanish Quick Use Guide/ Guía española para el uso rápido</b> ....	<b>168</b>

## Accessories

Check the accessories before using this unit.

### Battery pack

VW-VBG260



### AC adaptor

VW-AD21PP



### DC cable

K2GJYYC00001



### AV cable

K2KC4CB00024



### Component cable

K2KZ9DB00004



### AC cable

K2CA2CA00025



### Remote control

N2QAEC000023

### Button-type battery

CR2025

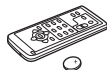

### USB cable

K2KZ4CB00011



### CD-ROM



## Quick Guide

### ■ Charging the battery

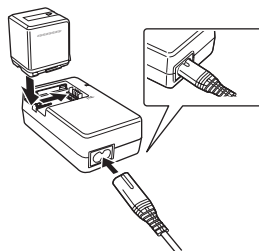

- 1 Connect the AC cable to the AC adaptor and the AC outlet.**
- 2 Put the battery on the battery mount by aligning the mark, and then securely plug it in.**

### ■ Inserting the battery

Push the battery against the battery holder and slide it until it clicks.

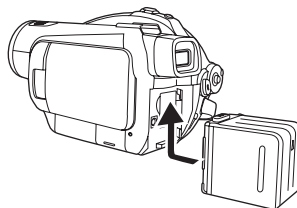

### ■ Removing the battery

While sliding the BATTERY lever, slide the battery to remove it.

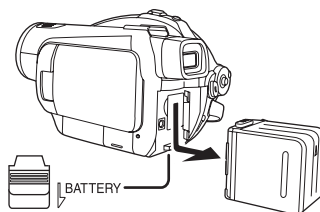

- **How to turn on the power**  
While pressing the lock release button **A**, set the mode dial to **□**, **●** or **▶**.

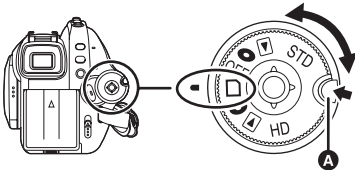

- **How to turn off the power**  
Set the mode dial to **OFF**.

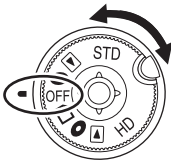

■ **Inserting/removing a disc**

- 1 Attach the battery or connect the AC adaptor.
- 2 Slide the **DISC EJECT** lever once and release it.

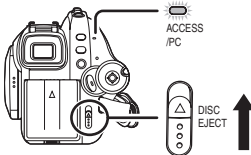

- 3 Open the cover of the disc compartment by hand and insert/remove the disc.

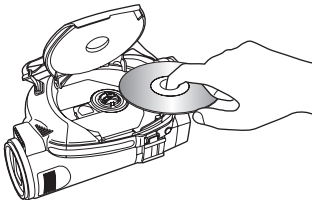

- 4 Push the section marked **PUSH CLOSE** on the cover of the disc compartment to close the cover.

■ **Inserting/removing an SD card**

- 1 Set the mode dial to **OFF**.
- 2 Open the LCD monitor and then insert/remove the SD card into/from the card slot.

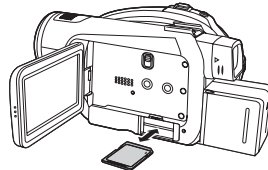

■ **Recording motion pictures**

- 1 Rotate the mode dial to select **●** or **□**.

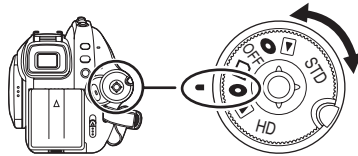

- 2 Press the recording start/stop button to start recording.

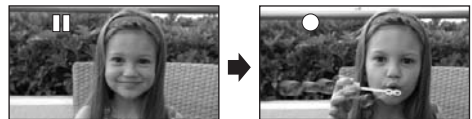
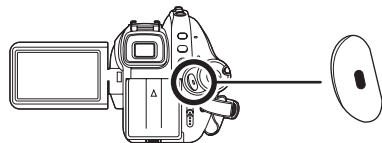

- 3 Press the recording start/stop button again to pause recording.

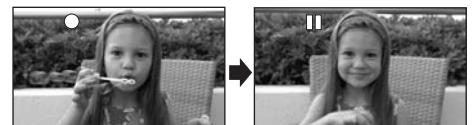

## ■ Recording still pictures (JPEG images) on an SD card

- 1 Rotate the mode dial to select **D**.

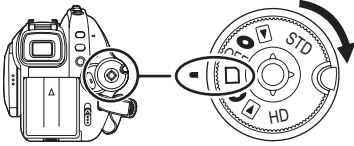

- 2 Press the PHOTO SHOT button halfway in order to adjust focusing. (For auto focus only)

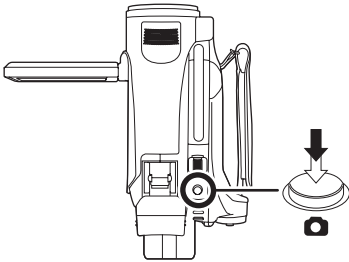

- 3 Press the PHOTO SHOT button fully to take the picture.

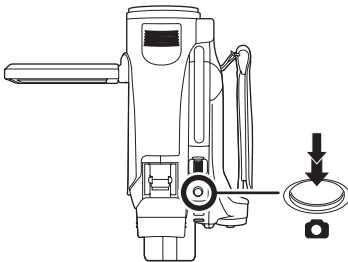

## ■ Motion picture playback

- 1 Rotate the mode dial to select **▶**.

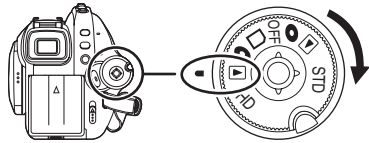

- 2 (HD mode only) Press the cursor button up and then select the **●** or **□** tab.

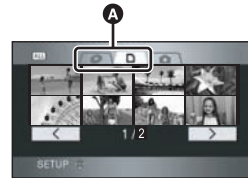

- A** Motion picture playback tab

- 3 Select the scene to be played back.

- 4 Press the cursor button.



- 5 Move the cursor button to operate.

- 
- ▶/||: Playback/Pause
  - ◀◀: Rewind playback
  - ▶▶: Fast forward playback
  - : Stops the playback and shows the thumbnails.
-

## ■ Still picture playback (JPEG images) on an SD card

1 Rotate the mode dial to select

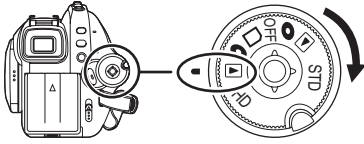

2 Press the cursor button up and then right to select the [  ] tab.

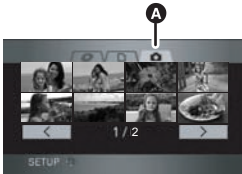

**A** Still picture playback tab

3 Select the file to be played back.

4 Press the cursor button.



5 Move the cursor button to operate.

---

**▶/||**: Slide show (playback of the still pictures on the SD card in numerical order) start/pause.

**<◀**: Plays back the previous picture.

**▶▶**: Plays back the next picture.

**■**: Stops the playback and shows the thumbnails.

---

## Before using

### Features of the High Definition Video Camera

#### Very clear high definition pictures

This unit can record highly detailed high definition images to an 8 cm (3") DVD disc or an SD card. You can watch images in high-resolution HD video if you connect this unit and a high definition TV and then play back the images. (→ 100)

You can also record to a conventional standard picture quality 8 cm (3") DVD disc by rotating the mode dial. Playback is possible on existing devices that do not support AVCHD.

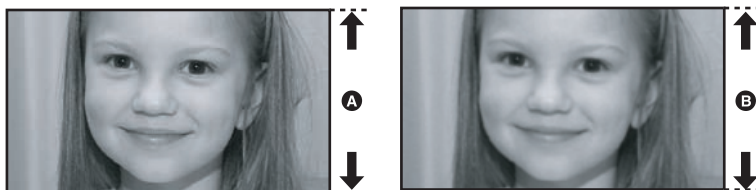

**A High Definition images (1920×1080)\*:**

Number of available scan lines 1080

**B Standard images until now (720×480):**

Number of available scan lines 480

#### High definition images

- High definition images have more than approximately 2 times the number of available scan lines and approximately 6 times\* the number of pixels compared with standard images.
- The still pictures above are images for explanation purposes.

\* If the recording mode is HG

#### What is the AVCHD?

This is a format for recording and playing back highly detailed high definition images.

Images are recorded based on the MPEG-4 AVC/H.264 codec for compressing images and audio is recorded in Dolby Digital. It is compatible with various discs such as DVD-RAM, DVD-RW, DVD-R and DVD-R DL. (→ 26, About recording formats in conventional standard picture quality)

#### Important Notice

**Do not insert discs which have been recorded in AVCHD format into devices which do not support the AVCHD format. In some cases the disc may get stuck in the device. The disc will not play back on devices that do not support the AVCHD format.**

**About the SDHC Memory Card and the compatibility of motion pictures recorded in high definition (Be careful about the following.)**

#### About the SDHC Memory Card

- It is not compatible with devices other than those that support SDHC.
- If you use the SDHC Memory Card in another device, use a device that is SDHC compatible. (→ 28)

## About the compatibility of discs recorded in HD mode (high definition picture quality) on this unit

- They are not compatible with devices other than those that support AVCHD. (Refer to the operating instructions of the device for details.)
- There are some cases where the recorded motion pictures cannot be played back, even if the device supports AVCHD. In such cases, play the recorded motion picture with this unit instead.
- Do not insert them into devices that are not compatible (DVD players, computers, etc. that do not support AVCHD) as they will not be played back.
- A format message may appear when you insert a disc into a device that is not compatible. (If you accidentally format the disc, the pictures you recorded will all be deleted.)
- We recommend setting [AUTO PROTECT] to [ON] (→ 97) to prevent important scenes being deleted by mistake. (This function's default setting is [ON].)

### Existing DVD recorders, DVD players, computers, etc. that do not support AVCHD.

- Discs recorded in STD mode can be played back on devices other than those that support AVCHD. (→ 108)

## Watching High Definition images

If you connect this unit and a high definition TV **A** with a HDMI cable (optional) **B** and then play back the pictures, you can enjoy watching them in high definition.

- Pictures recorded in STD mode cannot be played back.

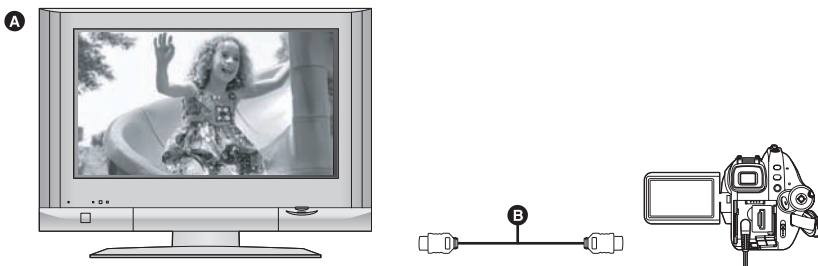

- If you connect this unit to a TV that does not support high definition, the images will be standard picture quality.

## When connecting to a TV that does not have a HDMI terminal

### Connecting with the component cable and the AV cable (→ 105)

- Pictures recorded in STD mode cannot be played back.

### Connecting with the AV cable (→ 106)

- The pictures cannot be played in high definition. They will be played back in standard picture quality.

## Using the remote control for the TV for playback

If you connect this unit to a Panasonic TV compatible with EZ Sync™ (HDAVI Control™) **A** with a HDMI cable (optional) **B**, you can use the remote control for the TV for playback. Refer to the operating instructions of the TV for details.

- Pictures recorded in STD mode cannot be played back.

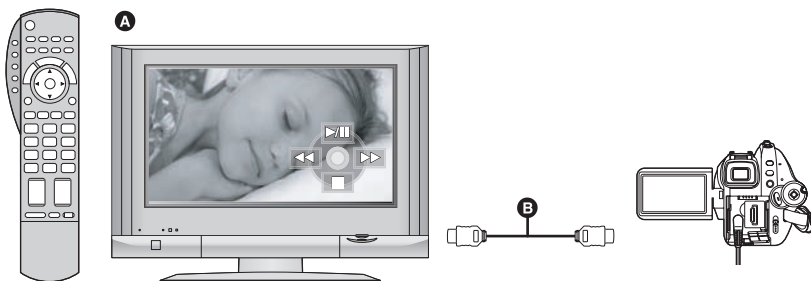

### ■ What is EZ Sync™?

- This function allows you to use your remote control for the Panasonic TV for easy operations when this unit has been connected to an EZ Sync™ compatible device using a HDMI cable (optional) for automatic linked operations.  
\* Not all operations are possible.
- EZ Sync™ is a unique Panasonic function built on a HDMI control function using the standard HDMI CEC (Consumer Electronics Control) specification. Linked operations with HDMI CEC compatible devices made by other companies are not guaranteed.
- This unit is compatible with EZ Sync™ Ver.2. EZ Sync™ Ver.2 is the newest Panasonic version and is also compatible with existing Panasonic EZ Sync™ devices. (As of February 2007)

### ■ Other linked operations

#### Turning the power off:

If you turn the power off with the remote control for the TV, the power on this unit also turns off.

#### Automatic input switching:

If you connect with a HDMI cable and then turn on the power on this unit, the input channel on the TV automatically switches to this unit's screen. If the TV's power is in standby status, it will turn on automatically (if [Set] has been selected for the TV's [Power on link] setting).

- Depending on HDMI terminal of the TV, the input channel may not switch automatically. In this case, use the remote control for the TV to switch input. (For details on how to switch input, please read the operating instructions for the TV.)



## Saving data to a computer

You can use the supplied software (HD Writer 2.0E for SX/SD) to copy data recorded on a disc or an SD card with this unit to the hard disk of the computer.

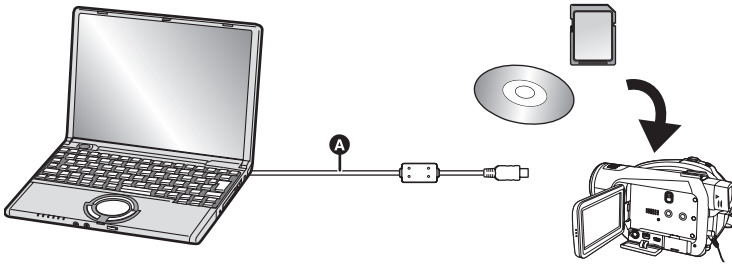

**A** USB cable (supplied)

### What you can do with HD Writer

#### Copying data to a computer

You can copy data on a disc or an SD card to the hard disk of the computer.

#### Writing data to media

You can copy motion picture data from the hard disk of the computer to an SD card or a disc.

#### Copying between media

You can copy motion picture data from an SD card to a disc or from a disc to an SD card.

#### Playing back on a computer

You can play back the images in high definition picture quality on a computer.

#### Easy editing

You can easily edit (split, merge, delete etc.) motion picture data that was copied to the hard disk of the computer. Also, you can convert data to MPEG2 format and create a DVD-Video.

- For details on how to use the software application, read the PDF operating instructions.

### Important Notice

**Do not insert a disc recorded in AVCHD format with the supplied HD Writer 2.0E for SX/SD in a device that does not support the AVCHD format. In some cases the disc may get stuck in the device. The disc will not play back on devices that do not support the AVCHD format.**

### The SD Media Storage (USA only)

The SD Media Storage (VW-PT2: optional) is convenient if you are on the move. It is an extremely compact, lightweight and easy to carry HDD (hard disk).

- If you insert an SD card with recorded motion pictures and still pictures in the SD Media Storage, the data can easily be saved to the SD Media Storage by pressing the copy button only.



## Parts identification and handling

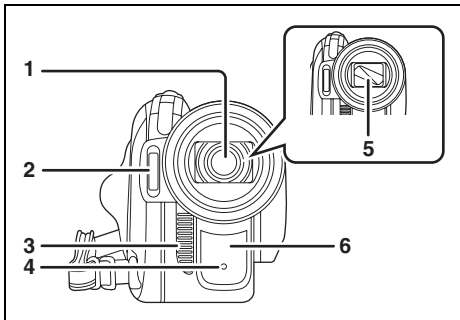

- 1 Lens (LEICA DICOMAR)
- 2 Built-in flash (→ 67)
- 3 Outlet
- 4 Recording lamp (→ 131)
- 5 Lens cover
- 6 White balance sensor/remote control sensor (→ 23, 77)

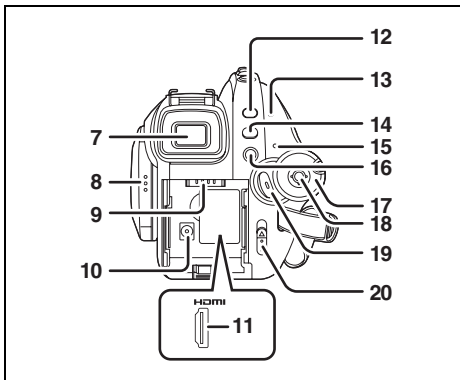

- 7 Viewfinder (→ 22)

Due to limitations in LCD production technology, there may be some tiny bright or dark spots on the viewfinder screen. However, this is not a malfunction and does not affect the recorded picture.

- 8 LCD monitor open latch (→ 21)
- 9 Battery holder (→ 31)
- 10 DC input terminal [DC IN 9.3V] (→ 35)
- 11 HDMI terminal [HDMI] (→ 101, 103)
- 12 PRE-REC button [PRE-REC] (→ 55)

- 13 Disc/computer access lamp [ACCESS/PC] (→ 39)
- 14 Menu button [MENU] (→ 47)
- 15 Status indicator (→ 36)
- 16 Delete button [⏮] (→ 86, 90)
- 17 Mode dial (→ 36)
- 18 Cursor button (→ 41)
- 19 Recording start/stop button (→ 53)
- 20 Disc eject lever [DISC EJECT] (→ 39)

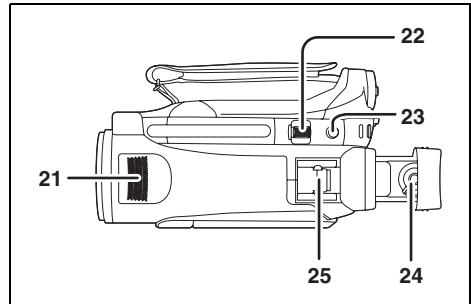

- 21 Internal stereo microphones
- 22 Zoom lever [W/T] (In recording mode) (→ 61)  
Volume lever [-VOL+] (In playback mode) (→ 83)
- 23 Photoshot button [📷] (→ 58)
- 24 Eyepiece corrector knob (→ 50)
- 25 Smart accessory shoe (→ 20)
  - Accessories, such as a video DC light/VW-LDH3 (optional), are attached here.

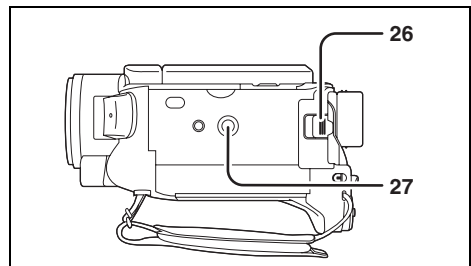

- 26 Battery release lever [BATTERY] (→ 31)
- 27 Tripod receptacle (→ 21)

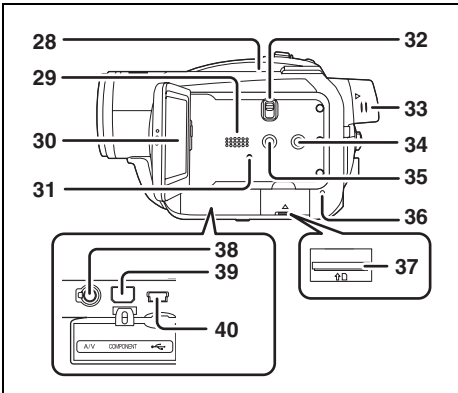

28 Inlet (cooling fan)

### About the cooling fan

- The cooling fan rotates to prevent the internal temperature rising. Take care not to cover the inlet and outlets when using this unit.

29 Speaker

30 LCD monitor (→ 21)

Due to limitations in LCD production technology, there may be some tiny bright or dark spots on the LCD monitor screen. However, this is not a malfunction and does not affect the recorded picture.

31 Reset button [RESET] (→ 145)

32 Mode select switch [AUTO/MANUAL/ FOCUS] (→ 52, 74)

33 Viewfinder extension knob (→ 22)

34 DISC COPY button [DISC COPY] (→ 89)

35 Power LCD EXTRA button [POWER LCD EXTRA] (→ 50)

36 Card access lamp [ACCESS] (→ 41)

37 Card slot (→ 40)

38 Audio-video output terminal [A/V] (→ 105, 106, 109)

- Use the supplied AV cable only.

39 Component terminal [COMPONENT] (→ 105)

40 USB terminal [↔] (→ 110, 119)

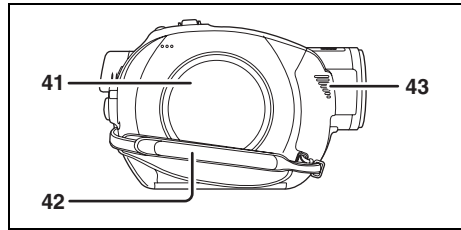

41 Disc compartment (→ 39)

42 Grip belt (→ 19)

43 Outlet

### Using grip belt

Adjust the belt length so it fits your hand.

**Adjust the belt length and the pad position.**

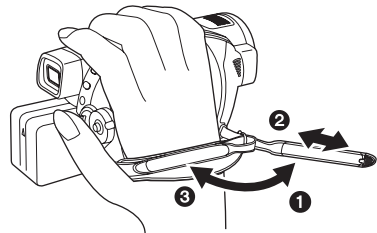

1 Flip the belt.

2 Adjust the length.

3 Replace the belt.

## Lens hood

**Rotate the lens hood counter-clockwise **A** to remove it. In order to attach it, place into slot **B**, and then rotate it clockwise **C**.**

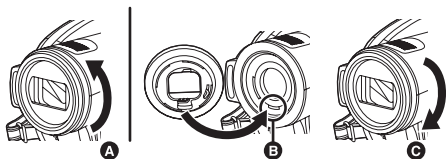

- When fitting the tele conversion lens (VW-T3714H; optional) or the wide conversion lens (VW-W3707H; optional), first remove the lens hood.  
(Refer to the operating instructions for the tele conversion lens or the wide conversion lens.)

## Smart accessory shoe

You can mount an optional microphone, light etc.

- When using an accessory for the smart accessory shoe, the power is supplied from this product.

**Connect to the smart accessory shoe.**

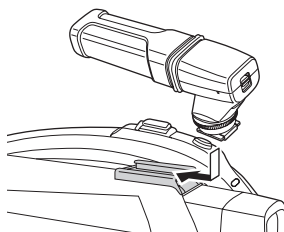

**If using an accessory for the smart accessory shoe, be sure to use the following.**

- Stereo zoom microphone (VW-VMH3; optional)
- Video DC light (VW-LDH3; optional)
- Video flash (VW-FLH3; optional)
- Mounting an accessory for the smart accessory shoe other than the above may cause the unit to malfunction.
- When the AC adaptor or the battery pack (VW-VBG130; optional) is used, you cannot use the video DC light.

## Tripod receptacle

This is a hole for attaching the unit to the optional tripod.

(Please carefully read the operating instructions for how to attach the unit to the tripod.)

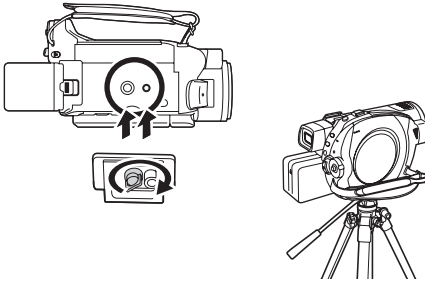

- When a tripod is used, you can perform operations easily using the remote control. (→ 22)

## Using the LCD monitor

You can record the image while viewing it on the LCD monitor.

- 1 Pull the LCD monitor out in the direction of the arrow with your fingers.**

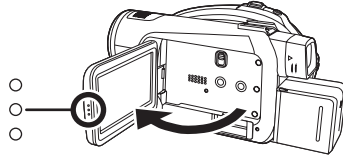

- It can open up to 90°.

- 2 Adjust the angle of the LCD monitor as desired.**

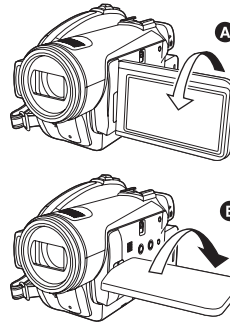

- It can rotate up to 180° **A** towards the lens or 90° **B** towards the viewfinder.

- The brightness and color level of the LCD monitor can be adjusted. (→ 49)
- The unit may be damaged or fail if the LCD monitor is forcibly opened or rotated.
- If the LCD monitor is rotated by 180° towards the lens and the viewfinder is extended (when recording yourself), the LCD monitor and the viewfinder simultaneously light.

## Using the viewfinder

### Pull out the viewfinder.

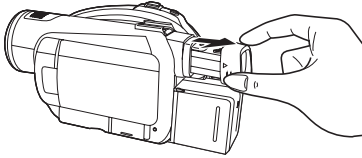

- The brightness of the viewfinder (→ 49) and the field of view can be adjusted. (→ 50)

## Using the remote control

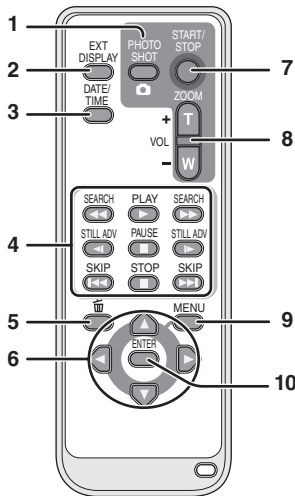

- 1 Photoshot button [📷]\*
- 2 On-screen display button [EXT DISPLAY] (→ 100)
- 3 Date/time button [DATE/TIME] (→ 49)
- 4 Playback operation buttons (→ 81, 82)
- 5 Delete button [🗑️]\*
- 6 Direction buttons [▲, ▼, ◀, ▶] (→ 48)
- 7 Recording start/stop button [START/STOP]\*
- 8 Zoom/volume buttons [ZOOM, VOL]\*
- 9 Menu button [MENU]\* (→ 48)
- 10 Enter button [ENTER] (→ 48)

\* means that these buttons function in the same manner as the corresponding buttons on the unit.

### Install a button-type battery

Install the supplied button-type battery in the remote control before using it.

- 1 While pressing the stopper **A**, pull out the battery holder.

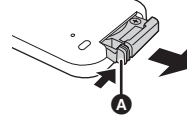

- 2 Set the button-type battery with its (+) mark facing upward and then put the battery holder back in place.

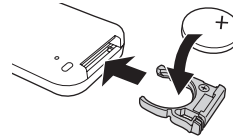

### Concerning the button-type battery

- When the button-type battery runs down, replace it with a new battery (part number: CR2025). The battery should normally last about 1 year, however this depends on how frequently the unit is used.
- Keep the button-type battery out of the reach of children to prevent swallowing.

### CAUTION

Danger of explosion if battery is incorrectly replaced. Replace only with the same or equivalent type recommended by the manufacturer. Dispose of used batteries according to the manufacturer's instructions.

Replace battery with Panasonic PART NO. CR2025 only. Use of another battery may present a risk of fire or explosion.  
Caution: Battery may explode if mistreated.  
Dispose of used battery promptly. Keep away from children.  
Do not recharge, disassemble or dispose of in fire.



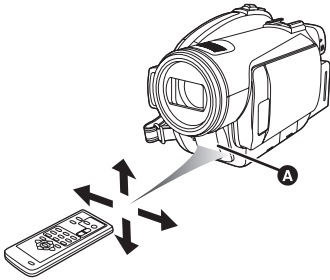

### ■ Remote control usable range

The distance between the remote control and the unit's remote control sensor **A**: Within approx. 5 m (16 feet)  
Angle: Approx. 10° up and 15° down, left, and right











- The remote control is intended for indoor operation. Outdoors or under strong light, the unit may not operate properly even within the usable ranges.

## Discs that can be used on this unit

	<b>DVD-RAM</b> 8 cm (3") Single sided/ double sided	<b>DVD-RW</b> 8 cm (3") Single sided/ double sided	<b>DVD-R</b> 8 cm (3") Single sided/ double sided	<b>DVD-R DL</b> 8 cm (3") Dual layer on single side
<b>Disc type</b>	  (DVD-RAM Ver. 2.1)	  [DVD-RW Ver. 1.1/ 2X-SPEED (2X/ 1X)]	  (DVD-R for General Ver. 2.0)	  (DVD-R for DL Ver. 3.0)

### ■ If recording in high definition picture quality (HD mode)

Disc type	DVD-RAM	DVD-RW	DVD-R	DVD-R DL
<b>Recording format</b>	AVCHD format	AVCHD format	AVCHD format	AVCHD format
<b>Characteristic</b>	Rewritable disc	Rewritable disc*1	One time recording disc	One time recording disc
<b>Display on the screen</b>				
<b>Indication in these instructions</b>				
<b>Functions</b>				
• Deleting recorded scenes	●	●*2	●*2	●*2
• Playback on other products*3	●	●*4	●*4	●*4
• Recording after finalizing	●*5	●*6	—	—

●: available —: not available

\*1 By formatting the disc, it can be used repeatedly. Please be aware that if a disc is formatted, then all the data recorded on the disc will be erased and it cannot be restored. (→ 93)

\*2 The remaining space on the disc will not increase even if scenes are deleted.

\*3 Products that support 8 cm (3") discs and the AVCHD.











\*4 Must be finalized on this unit. (→ 94)

\*5 Does not need to be finalized.

\*6 Un-finalize the disc. (→ 96)



## ■ If recording in conventional standard picture quality (STD mode)

Disc type	DVD-RAM	DVD-RW		DVD-R	DVD-R DL
<b>Recording format</b>	DVD Video Recording format (VR format)	DVD Video Recording format (VR format)	DVD-Video format (Video format)	DVD-Video format (Video format)	DVD-Video format (Video format)
<b>Characteristic</b>	Rewritable disc	Rewritable disc	Rewritable disc*1	One time recording disc	One time recording disc
<b>Display on the screen</b>					
<b>Indication in these instructions</b>					
<b>Functions</b>					
● Deleting recorded scenes	●	●	—	—	—
● Editing on this unit	●	●	—	—	—
● Playback on other products*2	●*3	●*4	●*5	●*5	●*5, 6
● Recording after finalizing	●*7	●	●*8	—	—

●: available —: not available

\*1 By formatting the disc, it can be used repeatedly. Please be aware that if a disc is formatted, then all the data recorded on the disc will be erased and it cannot be restored. (→ 93)

\*2 DVD player or DVD recorder that supports 8 cm (3") discs.

\*3 Can only be played back on a device that supports DVD-RAM.

\*4 Must be finalized on this unit. (→ 94) Playback of DVD-RW (VR format) is possible on compatible products.

\*5 Must be finalized on this unit. (→ 94)

\*6 Can only be played back on a device that supports DVD-R DL.

\*7 Does not need to be finalized.

\*8 Un-finalize the disc. (→ 96)

- **Still pictures cannot be recorded on a disc with this unit.**

- You cannot record or play continuously from one side of the disc to the other when using a double sided disc. You will need to eject the disc and turn it over.

- Discs inserted in a holder, cartridge, or caddy case cannot be used unless they are removed from the containers prior to use.

- It is recommended that you use Panasonic discs. Usually discs compatible with the DVD standard can be used for recording and playback with no problems. However, some commercially available discs do not meet the DVD standard for quality and performance. If you use one of these discs, you may not be able to record or playback normally. (The message "RECOMMENDED TO USE PANASONIC DISC" appears.)

- **(HD mode) Discs recorded in high definition picture quality with this unit may not be playable on other devices even if the other devices support AVCHD. In such cases, play back the discs with this unit instead.**

- (STD mode) Recording on DVD-R in DVD Video Recording format is not supported.

- **When using DVD-RW, DVD-R or DVD-R DL do not perform the following as it may make the disc unusable.**

- Record on a disc with other products after recording on it with this unit.
- Record on a disc with this unit after recording on it with other products.
- Insert an un-finalized disc in any other products.

### ■ About recording formats in conventional standard picture quality

#### What is the DVD Video Recording format (VR format)?

This is a recording format which allows you to erase recorded images and use one disc repeatedly. You can also edit images. You can record on DVD-RAM and DVD-RW in VR format with this unit.

#### What is the DVD-Video format (Video format)?

By finalizing the disc, it can be played back on most DVD players.

You can record on DVD-RW and DVD-R in Video format with this unit.

- Refer to P14 about the recording format of high definition picture quality.

### ■ About DVD-R DL (dual layer on single side)

DVD-R DL (dual layer on single side) discs have two layers of recording and playback surface on one side. If the recording does not fit on the first layer (L0), it continues on the second layer (L1). In this case, the recording continues across two layers.

In STD mode, the recording is divided into two scenes at the point where the layers switch.

This unit automatically switches layers during disc playback so you can play back the whole of the disc continuously like a normal disc.

However, the picture or the sound may momentarily stop at the point where the layers switch.

### ■ Examples of discs that cannot be used on this unit

- Discs other than those with diameter of 8 cm (3")
- Dual layer on single side discs other than DVD-R DL
- +RW
- +R
- DVD-ROM
- CD-RW
- CD-R
- CD-ROM
- CD

## When using new DVD-RAM or DVD-RW

### ◇ HD mode

When a brand-new DVD-RAM or DVD-RW is inserted in this unit, you have to first format the disc. See the illustration below.

**Move the cursor button up or down to select [YES], then press the cursor button.**



### ◇ STD mode

When using DVD-RW, select whether to record in DVD Video Recording format (VR format) or DVD-Video format (Video format) and then format the disc. (→ 26, About recording formats in conventional standard picture quality)

When a brand-new DVD-RW is inserted in this unit, the screen shown in the illustration may be displayed.

## 1 Move the cursor button left or right to select [YES], then press the cursor button.



## 2 Select format type, then press the cursor button.



**[VIDEO]:** DVD-Video format (Cannot edit or delete scene)

**[VR]:** DVD Video Recording format (Allows editing and deleting of scene)

## 3 When the confirmation message appears, select [YES], then press the cursor button.

- If the disc is formatted, then all the data recorded on the disc will be erased.
- To change the format type, format the disc again. (→ 93)

## When inserting a disc recorded on another device or in another mode

When a DVD-RAM or a DVD-RW recorded on another device or in another mode is inserted in this unit, the screen shown in the illustration may be displayed.

If the disc is formatted (→ 93), then it can be used. However, all the data recorded on the disc will be erased. Check the data before formatting.

- DVD-R or DVD-R DL recorded on another device cannot be formatted and used for recording.

### ◇ HD mode

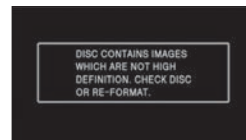

- First format the disc in HD mode. (→ 93)

### ◇ STD mode

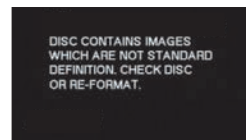

- First format the disc in HD mode, then format it again in STD mode and use it. (→ 93)

## Cards that you can use with this unit

Card type	SD Memory Card			SDHC Memory Card
Capacity	8 MB, 16 MB	32 MB, 64 MB, 128 MB	256 MB, 512 MB, 1 GB, 2 GB	4 GB, 8 GB
Motion picture recording	Cannot be used.	Cannot be guaranteed in operation.*	Refer to "About SD cards that you can use for motion picture recording".	
Still picture recording	Can be used.			

\* The recording may suddenly stop during motion picture recording depending on the SD card you use. (→ 54)

- Functions that can be used for motion picture recording/motion picture playback using an SD card are indicated by **VIDEO** and functions that can be used for still picture recording/still picture playback using an SD card are indicated by **PHOTO** in these operating instructions.

This unit (an SDHC compatible device) is compatible with both SD Memory Cards and SDHC Memory Cards. You can use SDHC Memory Cards on devices that are compatible with them. However, you cannot use SDHC Memory Cards on devices that are only compatible with SD Memory Cards. (When using an SDHC Memory Card on another device, always read the operating instructions of that device.)

## About SD cards that you can use for motion picture recording

We recommend using SD Memory cards and SDHC Memory cards conforming to Class 2 or higher of the SD Speed Class Rating or the following SD cards made by Panasonic for motion picture recording.

Card type	Pro High Speed SD Memory Card	Super High Speed SD Memory Card	High Speed SD Memory Card	SDHC Memory Card
256 MB	—	RP-SDH256*1	RP-SDR256	—
512 MB	RP-SDK512*1	RP-SDH512*1	RP-SDR512	—
1 GB	RP-SDK01G*1 RP-SDV01G	RP-SDH01G*1	RP-SDQ01G*1 RP-SDR01G	—
2 GB	RP-SDK02G*1 RP-SDV02G	—	RP-SDQ02G*1 RP-SDR02G*1 RP-SDM02G	—
4 GB	—	—	—	RP-SDM04G RP-SDR04G*1 RP-SDV04G
8 GB	—	—	—	RP-SDV08G*2

\*1 No longer made.

\*2 Available from Sep. 2007

- Operation in motion picture recording is not guaranteed with an SD card memory from 32 MB to 8 GB except the cards above. (The recording may suddenly stop during motion picture recording.)
- For the purposes of these operating instructions, SD Memory Card and SDHC Memory Card are referred to as the “SD card”.
- This unit supports SD Memory Cards formatted in FAT12 system and FAT16 system based on SD Memory Card Specifications and SDHC Memory Cards formatted in FAT32 system.
- If you wish to use Memory Cards that are 4 GB and 8 GB, only SDHC Memory Cards can be used.
- 4 GB (or more) Memory Cards that do not have the SDHC logo are not based on SD Memory Card Specifications.
- Use this unit to format SD cards. If an SD card is formatted on other products (such as a computer), the time spent for recording may become longer and you may not be able to use the SD card. (→ 94) **(Do not format it on a PC etc.)**
- When the write-protect switch **A** on the SD card is locked, no recording, deletion or editing will be possible on the card.
- Keep the Memory Card out of reach of children to prevent swallowing.
- A MultiMediaCard cannot be used on this unit.

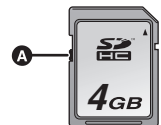

## Disc and card handling

### How to hold a disc or card

Do not touch the recorded surface or the terminal surface.



### When inserting/removing a disc

Do not allow fingerprints or dirt to get on the recording/playback side of the disc.

- If there are scratches or dirt (e.g. dust or fingerprints) on the recording/playback side of the disc, normal recording/playback may not be possible and the following may occur:
  - Recording/playback is not possible.
  - The image or the sound is interrupted or stops momentarily.
  - Noise appears on the image or the sound.
  - The message “NO DATA.”, “PLEASE CHECK THE DISC.”, “CHECK THE DISC AFTER PUSHING THE RESET SWITCH TO REPAIR THE DISC.”, etc. appears.

### If there is dirt on the disc

- Clean it with a soft cloth. Wipe the disc from the center to the outer edge to remove the dirt. Do not use force when wiping the disc as it may scratch it. Also, do not use solvents (thinner, water, antistatic agent, detergent etc.).



### Handling precautions

- Be careful about scratches and dirt.
- Do not attach labels or stickers to discs. (This may cause disc warping and un-balanced rotation, rendering it unusable.)
- Write on the label side of the disc only with a soft, oil-based felt pen. Do not use ballpoint pens or other hard writing implements.

- Do not use record cleaning sprays, benzene, thinner, static electricity prevention liquids or any other solvent.
- Do not use scratch-proof protectors or covers.
- Do not drop, stack, or impact discs. Do not place objects on them.
- Do not use the following discs:
  - Discs with exposed adhesive from removed stickers or labels.
  - Discs that are badly warped or cracked.
  - Irregularly shaped discs, such as heart shapes.

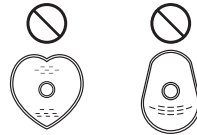

- Do not expose the terminals of the SD card to water, garbage or dust.
- Do not place discs or SD cards in the following areas:
  - In direct sunlight.
  - In very dusty or humid areas.
  - Near a heater.
  - Locations susceptible to significant difference in temperature (condensation can occur).
  - Where static electricity or electromagnetic waves occur.
- To protect discs and cards, return them to their cases when you are not using them.

## Setup

### Charging the battery

When this unit is purchased, the battery is not charged. Charge the battery before using this unit.

**If the DC cable is connected to the AC adaptor, then the battery will not charge. Remove the DC cable from the AC adaptor.**

- Refer to page 32 concerning batteries that can be used with this unit.

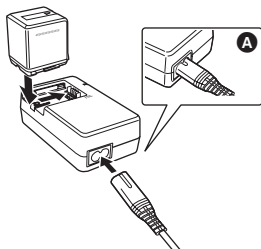

#### 1 Connect the AC cable to the AC adaptor and the AC outlet.

- Remove the DC cable beforehand.

#### 2 Put the battery on the battery mount by aligning the mark, and then securely plug it in.

- The output plug of the AC cable is not completely connected to the AC adaptor jack. As shown in **A**, there is a gap.

### ■ Charging lamp

**Lights up:**

Charging

**Goes off:**

Charging completed

**Flashing:**

Make sure that the terminals of the battery or the AC adaptor are not exposed to dirt, foreign objects or dust, then reconnect them properly. Disconnect the AC cable from the AC outlet when you remove dirt, foreign objects or dust on the terminals of the battery or the AC adaptor. If the charging lamp is still flashing, something may be wrong with the battery or AC adaptor. Contact your dealer.

- Battery charging time (→ 32)
- We recommend using Panasonic batteries (→ 10, 32, 159).
- If you use other batteries, we cannot guarantee the performance/quality of this product.

### Inserting/Removing the battery

#### Inserting the battery

Push the battery against the battery holder and slide it until it clicks.

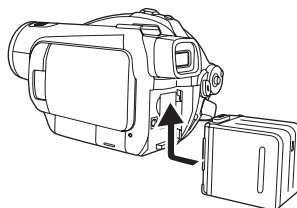

#### Removing the battery

While sliding the BATTERY lever, slide the battery to remove it.

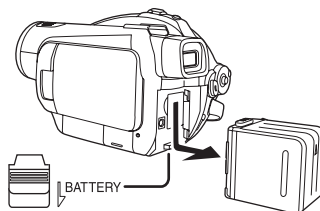

- Hold the battery with your hand so it does not fall.
- Before removing the battery, be sure to set the Mode dial to OFF and check that the status indicator is off.

### CAUTION

Danger of explosion if battery is incorrectly replaced. Replace only with the same or equivalent type recommended by the manufacturer. Dispose of used batteries according to the manufacturer's instructions.

---

## Charging and recording time

---

### ■ About batteries that you can use with this unit

The Panasonic battery that can be used with this unit is VW-VBG260/VW-VBG6/VW-VBG130.

VW-VBG260/VW-VBG6/VW-VBG130 come with a function to check whether the battery and unit can be safely used together.

- Batteries made by other companies which have been certified by Panasonic may be used with this unit, but we offer no guarantee as to the quality, performance or safety of such batteries.
- In order to safely use the unit we recommend that you use genuine Panasonic batteries which have been subject to our quality control process.
- We cannot accept any liability whatsoever for damages to the unit or accidents caused by non-genuine Panasonic batteries (including those that have been certified by Panasonic).
- Exercise care when purchasing batteries. Many fake or imitation batteries have been found among those sold at unusually low prices and those which customers cannot check for themselves before purchasing.

### ■ Charging time

The times shown in the tables below are for when the temperature is 25 °C (77 °F) and the humidity is 60%.

If the temperature is higher or lower than 25 °C (77 °F), the charging time will become longer.

Battery model number	Voltage/capacity	Charging time
Supplied battery/ VW-VBG260 (optional)	7.2 V/2640 mAh	4 h
VW-VBG130 (optional)	7.2 V/1320 mAh	2 h 20 min
VW-VBG6 (optional)	7.2 V/5800 mAh	8 h 50 min

- The charging time shown in the table are approximations.
- "8 h 50 min" indicates 8 hours 50 minutes.

- 
- When you charge a battery that has not been used for long time, the charging time will become longer.



## Recordable time

- The times shown in the table below are for when the temperature is 25 °C (77 °F) and the humidity is 60%. These times are approximations. The times indicate the recordable time when the viewfinder is used. The times in parentheses indicate the recordable time when the LCD monitor is used.
- The actual recordable time refers to the recordable time on a disc when repeatedly starting/stopping recording, turning the unit on/off, moving the zoom lever, etc.

Battery model number	Voltage/capacity	Recording mode		Maximum continuously recordable time	Actual recordable time
Supplied battery/ VW-VBG260 (optional)	7.2 V/ 2640 mAh	Disc* (HD mode)	HG	1 h 55 min (1 h 50 min)	50 min (50 min)
			HN	2 h 5 min (2 h)	50 min (50 min)
			HE	2 h 10 min (2 h 5 min)	55 min (50 min)
		Disc* (STD mode)	XP	2 h (1 h 55 min)	50 min (50 min)
			SP	2 h 10 min (2 h 5 min)	55 min (50 min)
			LP	2 h 20 min (2 h 10 min)	55 min (55 min)
		SD card (HD mode)	HG	2 h 45 min (2 h 35 min)	1 h 40 min (1 h 35 min)
			HN	2 h 50 min	1 h 45 min
			HE	2 h 40 min	1 h 35 min
VW-VBG130 (optional)	7.2 V/ 1320 mAh	Disc* (HD mode)	HG	1 h (55 min)	25 min (25 min)
			HN	1 h 5 min (1 h 5 min)	25 min (25 min)
			HE	1 h 10 min (1 h 5 min)	30 min (25 min)
		Disc* (STD mode)	XP	1 h 5 min (1 h)	25 min (25 min)
			SP	1 h 10 min (1 h 5 min)	30 min (25 min)
			LP	1 h 15 min (1 h 10 min)	30 min (30 min)
		SD card (HD mode)	HG	1 h 30 min (1 h 20 min)	55 min (50 min)
			HN	1 h 30 min	55 min
			HE	1 h 25 min	50 min

Battery model number	Voltage/capacity	Recording mode		Maximum continuously recordable time	Actual recordable time
VW-VBG6 (optional)	7.2 V/ 5800 mAh	Disc* (HD mode)	HG	5 h (4 h 35 min)	2 h 10 min (2 h)
			HN	5 h 15 min (5 h)	2 h 10 min (2 h 5 min)
			HE	5 h 35 min (5 h 15 min)	2 h 20 min (2 h 10 min)
		Disc* (STD mode)	XP	5 h (4 h 50 min)	2 h 15 min (2 h 10 min)
			SP	5 h 30 min (5 h 15 min)	2 h 15 min (2 h 10 min)
			LP	5 h 45 min (5 h 35 min)	2 h 25 min (2 h 20 min)
		SD card (HD mode)	HG	6 h 50 min (6 h 25 min)	4 h 15 min (4 h)
			HN HE	7 h 5 min (6 h 40 min)	4 h 25 min (4 h 5 min)

\* When using a DVD-RAM disc

- The recordable times shown in the table are approximations.
- "1 h 30 min" indicates 1 hour 30 minutes.

- The recordable times will vary depending on the status of use. These times are approximations. The recordable time will become shorter in the following cases:
  - When you use both the viewfinder and the LCD monitor simultaneously while rotating the LCD monitor frontward to record yourself, etc.
  - When you use this unit with the LCD monitor lit up by pressing the POWER LCD EXTRA button.
  - When you use accessories fitted on the unit's smart accessory shoe such as the stereo zoom microphone and video DC light, etc.
- The batteries heat up after use or charging. This unit will also heat up while being used. This is not a malfunction.
- Be aware that the operating time of the battery will become shorter in low temperatures. We recommend charging a spare battery for use when recording.

## ■ About the remaining battery capacity indication

The remaining battery capacity is displayed in minutes when using the Panasonic battery that you can use for this unit. It may take time to display the remaining battery capacity.

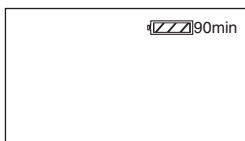

- The display changes as the battery capacity reduces.  

 If there is less than 3 minutes remaining, then will become red. If the battery discharges, then will flash.
- The remaining battery capacity may not be displayed correctly where the temperature is low or high or if the battery was not used for a long period of time.  
 To correctly display the remaining battery capacity, recharge the battery, discharge it and then charge it again. (Even if this operation is performed, it may not be possible to display the remaining battery capacity correctly if the battery was used for a long period of time where the temperature is low or high or if the battery was repeatedly charged.)
- The maximum amount of remaining battery capacity able to be indicated is 999 minutes. If the actual remaining time exceeds 999 minutes, the indication will stay green and will not change until the remaining time falls below 999 minutes.
- The time displayed is an approximation of the remaining time your battery will provide useful power. The actual time can vary depending on your actual use.
- When rotating the mode dial to switch modes, the time indication will turn off in order to recalculate the remaining battery capacity time.
- When using the AC adaptor or batteries made by other companies, the remaining battery capacity will not be shown.

## Connecting to the AC outlet

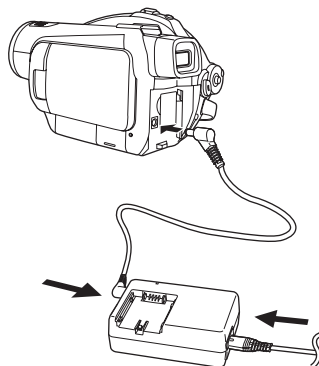

- 1 Connect the AC cable to the AC adaptor and the AC outlet.**
- 2 Connect the DC cable to the AC adaptor.**
- 3 Connect the DC cable to the DC input terminal DC IN 9.3V.**



- Do not use the AC cable with any other equipment as it is designed only for this unit. Do not use the AC cable from other equipment with this unit.
- **While the DC cable is connected to the AC adaptor, the battery will not charge.**

## Selecting a mode (Turning the unit on/off)

Rotate the mode dial to switch to recording, playback or power OFF.

- Rotate the mode dial slowly.

### How to turn on the power

While pressing the lock release button, set the mode dial to  ,  or  .

- Rotate the mode dial while at the same time pressing in the lock release button **A** if changing from OFF to another mode.
- Align with the mark **B**.

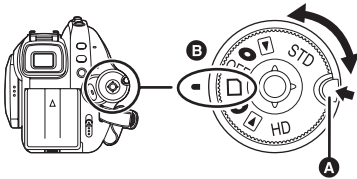

The status indicator lights and the power turns on.

- The lens cover opens in recording mode.
- When the unit is turned on for the first time, a message asking you to set the date and time will appear. Select [YES] and set the date and time. (→ 48)



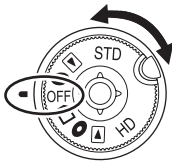

### How to turn off the power

Set the mode dial to OFF.



The status indicator goes off and the power turns off.

- The lens cover closes when the mode dial is set to OFF.

STD mode		<b>Disc Recording mode (→ 53)</b> Use this to record motion pictures in standard picture quality on a disc.
		<b>Playback mode (→ 80)</b> Use this to play back motion pictures recorded in standard picture quality on a disc.
		<b>OFF</b> The power turns off.
HD mode		<b>SD Card Recording mode (→ 53, 58)</b> Use this to record motion pictures and still pictures in high definition picture quality on an SD card.
		<b>Disc Recording mode (→ 53, 58)</b> Use this to record motion pictures in high definition picture quality on a disc and still pictures in high definition picture quality on an SD card.
		<b>Playback mode (→ 79, 84)</b> Use this to play back motion pictures recorded in high definition picture quality on a disc and motion pictures and still pictures recorded in high definition picture quality on an SD card.



- Do not forcefully rotate the dial.
- If changing from HD mode to STD mode or STD mode to HD mode when a disc is inserted in this unit, first slide the DISC EJECT lever and then change the mode.
- STD and HD mode cannot be recorded on the same disc. When using double sided media, one side can be used for STD and other side for HD mode.
- While recording in HD mode if you wish to switch to STD mode, remove the current disc and insert another disc to record in STD mode, and vice versa.

When the power is turned on for the first time after changing the disc or battery, the unit carries out a recognition procedure to check that there are no problems with the disc. If you want to start using the unit as soon as you turn on the power, do the following.

- 1 **Turn on the power.**
- 2 **After “READING DISC...” disappears from the screen, turn off the power.**

- Depending on the condition of the disc, it may take longer than this.
- If the date and time are not set, it will take longer than usual before you can start recording.

### How to turn the power on and off with the LCD monitor/viewfinder

When the mode dial is set to  or , the power can be turned on and off with the LCD monitor and the viewfinder.

**■ To turn on the power**  
Open the LCD monitor or extend the viewfinder.

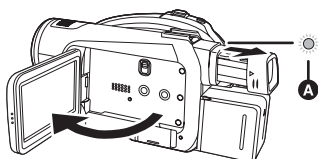

The status indicator **A** lights and the power turns on.

- It lights up when the viewfinder is extended with the LCD monitor closed. (When the LCD monitor is opened, the viewfinder turns off.)

**■ To turn off the power**  
Close the LCD monitor and retract the viewfinder.

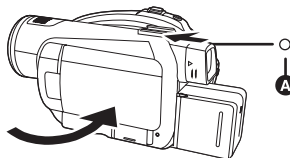

The status indicator **A** goes off and the power turns off. (If [QUICK START] (→ 38) is set to [ON], the unit goes into quick start standby mode and the status indicator flashes green.)

- The power will not turn off unless the LCD monitor is closed and the viewfinder is retracted.
- The power will not turn off while recording motion pictures even if the LCD monitor is closed and the viewfinder is retracted.

Set the mode dial to OFF when this unit is not being used.

## Quick start

When quick start is ON the battery power is still being consumed, even when the LCD monitor and the viewfinder are closed.

This unit will resume recording/pause mode about 1.7 seconds after the LCD monitor or the viewfinder are reopened.

- When in quick start standby mode, about 70% of the power used in recording pause mode is being consumed so the recording time will be reduced.
- This is only activated in the following case.
  - When the mode dial is set to **□** and an SD card is inserted.

- 1 Press the MENU button, then select [SETUP] → [QUICK START] → [ON] and press the cursor button.

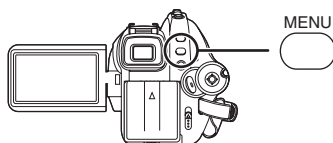

- 2 Close the LCD monitor and retract the viewfinder while the mode dial is set to **□**.

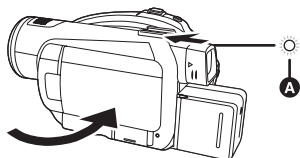

The status indicator **A** flashes green and the unit goes into quick start standby mode.

- The lens cover does not close.

- 3 Open the LCD monitor or extend the viewfinder.

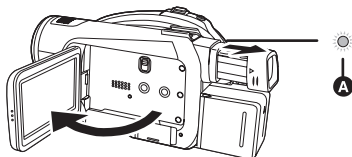

The status indicator **A** lights red and the unit is put into recording pause approx. 1.7 seconds after it is turned on.

### To cancel Quick start

Press the MENU button, then select [SETUP] → [QUICK START] → [OFF] and press the cursor button.

- The status indicator goes off, the lens cover closes and the power turns off if the mode dial is set to OFF while the unit is in quick start standby mode.
- The status indicator goes off and the power turns off if quick start standby mode continues for approx. 5 minutes.

- Quick start standby mode is canceled, if
  - the mode dial is switched
  - the battery is removed or the AC adaptor is disconnected
- In the quick start mode, it may take some time for automatic white balance to adjust, if the scene being recorded has a light source different from the scene last recorded. (When the MagicPix function is used, however, the white balance of the scene last recorded is retained.)
- In the quick start mode, the zoom magnification becomes 1× and the picture size may differ from what it was before quick start standby mode.
- If [POWER SAVE] (→ 131) is set to [5 MINUTES] and the unit automatically goes into quick start standby mode, close the LCD monitor and then open it again.

## Inserting/removing a disc

The cover of the disc compartment will not open unless the unit has a charged battery or is connected to the AC adaptor.

**1 Attach the battery or connect the AC adaptor.**

**2 Slide the DISC EJECT lever up and release it.**

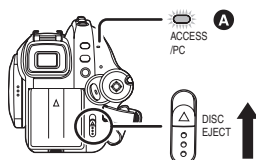

A few moments after the ACCESS/PC lamp **A** blinks, the cover of the disc compartment will open slightly.

**3 Open the cover of the disc compartment and insert/remove the disc.**

### Inserting disc

Place the disc onto the spindle in the center and then push the disc down until it clicks into place.

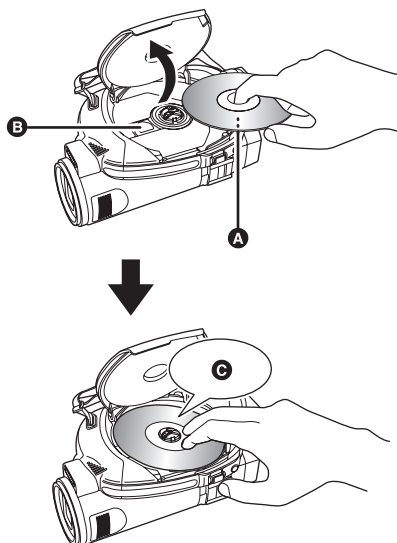

**A** Recording/playback side

**B** Pickup lens (Reads disc)

**C** Press until it clicks.

- Be careful not to touch the recording/playback side of the disc when inserting/removing it.

### Removing disc

While pressing down on the spindle, grasp the edge of the disc and gently lift it out.

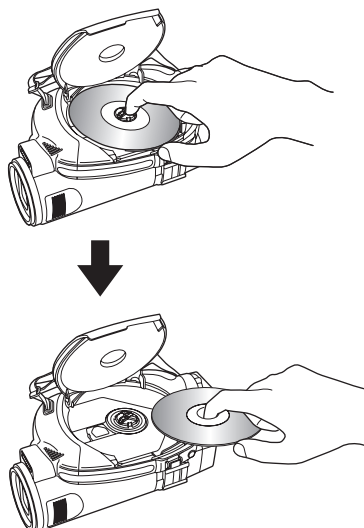

**4 Push the section marked PUSH CLOSE on the cover of the disc compartment to close the cover.**

- When using new DVD-RAM or DVD-RW (→ 27)
- When inserting a disc recorded on another device or in another mode (→ 27)
- You cannot remove a disc while recording motion pictures on an SD card or in PRE-REC. (→ 55)

## Identifying recording/playback sides of disc

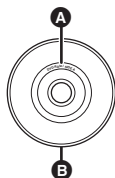

**A** "SIDE A" mark

**B** The opposite side is the "SIDE A" recording/playback side.

### Single sided disc/dual layer on single side disc:

The recording/playback side is opposite to the labelled side.

### Double sided disc:

The "SIDE A" recording/playback side is the side opposite the side with the "SIDE A" mark.

The "SIDE B" recording/playback side is the side with the "SIDE A" mark.

- Do not use excessive force when opening the cover.
- Do not touch the pickup lens or the recording/playback side of the disc.  
This may impair recording and playback.
- Insert the disc securely to prevent damage.
- When you open the cover, the ACCESS/PC lamp flashes. Do not leave the cover open.
- If the cover is open, the power will not turn off even if the Mode dial is set to OFF.
- If the disc is not correctly inserted, the cover will not close. Never try to forcibly close the cover. This could cause damage. Reinsert the disc properly.
- If a single sided disc is inserted into the unit with the printed label facing the inside, an error message will appear. Remove the disc and reinsert it with its recording/playback side facing the inside.
- Do not allow the recording/playback side to become dirty or scratched.
- Do not remove the battery pack or disconnect the AC adaptor while removing the disc or until power is completely turned off. If you do, the cover will not open. If this happens, reattach the battery pack or reconnect the AC adaptor, slide the DISC EJECT lever once, and then release it. A repair disc message may be

displayed when the power is turned back on. (→ 137)

- Do not insert anything other than the 8 cm (3") DVD-RAM, DVD-RW, DVD-R or DVD-R DL disc into the disc compartment. Doing so could cause malfunctions. (→ 26)
- Do not touch the pickup lens or other parts inside the disc compartment. Be sure not to touch the area around the pickup lens as it can become extremely hot.

### After inserting a disc/After recording finishes

While the ACCESS/PC lamp is lit, the disc is rotating and disc information is being recorded. If the power supply is interrupted at this time, the disc may become unusable. Do not disconnect the AC adaptor or remove the battery. Also, do not shake or bump into the unit while the lamp is on.

## Inserting/removing an SD card

**Be sure to set the mode dial to OFF before inserting/removing an SD card.**

**If the SD card is inserted or removed while the power is on, this unit may malfunction or the data recorded on the SD card may be lost.**

### 1 Set the mode dial to OFF.

- Check that the status indicator has gone off.

### 2 Open the card slot cover.

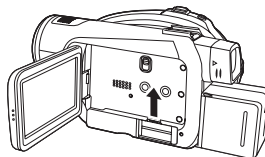



### 3 Insert/remove the SD card into/ from the card slot.

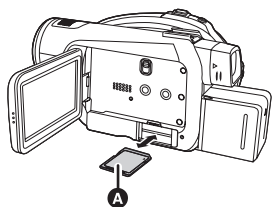

- When inserting an SD card, face the label side **A** upwards and press it straight in as far as it will go.
- When removing the SD card, press the center of the SD card and then pull it straight out.

### 4 Securely close the card slot cover.

#### ■ About the SD card

- Do not touch the terminals on the back of the SD card.
- Electrical noise, static electricity or the failure of this unit or the SD card may damage or erase the data stored on the SD card. We recommend saving the important data recorded on this unit to a PC using the USB cable (supplied), HD Writer 2.0E for SX/SD etc. (→ 123) (We recommend using HD Writer 2.0E for SX/SD to acquire data recorded on this unit.)
- When using an SD card on which data has been written many times, the remaining time left for recording may be reduced. (→ 54)

#### ■ Card access lamp [ACCESS]

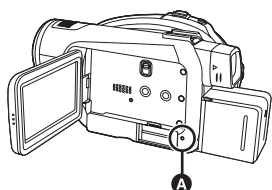

- When this unit accesses the SD card (reading, recording, playback, erasing, etc.), the access lamp **A** lights up.
- When the lamp is lit, do not:
  - Remove the SD card
  - Operate the mode dial
  - Remove the battery or disconnect the AC adaptor

Performing the above while the lamp is on may result in damage to data/SD card or this unit.

### How to use the cursor button

This unit has a cursor button **A** for selecting functions, performing operations, etc. so it is easy to operate this unit with one hand.

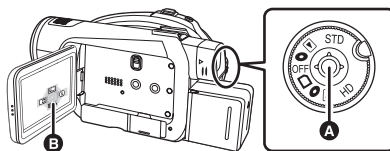

- B** Operating the operation icons and menu screens that are displayed

#### Basic operations



The following describes operations on the menu screen and selection of files on the thumbnail view screen, etc.

**Move the cursor button up, down, left, or right to select an item or scene, and then press the cursor button to set it.**



- 1** Select by moving up.
  - 2** Select by moving down.
  - 3** Select by moving left.
  - 4** Select by moving right.
  - 5** Press the cursor button to set the item.
- Menu screen operations (→ 47)

### Operations during recording

◇ Rotate the mode dial to select  or .

**1** Press the center of the cursor button, and icons will be displayed on the screen.



- The indication disappears when the center of the cursor button is pressed again.
- The indication changes each time the cursor button is moved down.

**2** Move the cursor button up, left or right to select an item.

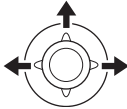

### Operations during playback

◇ Rotate the mode dial to select .

**1** Move the cursor button up, down, left or right to select the scene to be played back and press the cursor button.

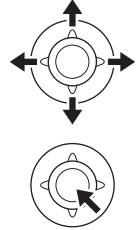

The selected scene is played back on the full screen. The operation icon is automatically displayed on the screen.

**2** Move the cursor button up, down, left or right to select the playback operation.

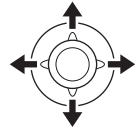

- The operation icon appears or disappears each time the center of the cursor button is pressed.

## Operation icons displayed in each mode

### HD Recording mode

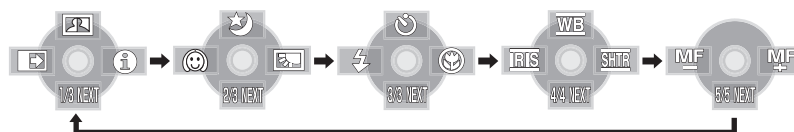

Icon	Direction	Function	Page	
(1/3)		▲	Intelligent contrast control	63
		◀	Fade	64
		▶	Help mode	46
(2/3)		▲	MagicPix	65
		◀	Soft skin mode	65
		▶	Backlight compensation	66
(3/3)		▲	Self-timer recording	66
		◀	Flash	67
		▶	Tele macro	69

### Set the AUTO/MANUAL/FOCUS switch to MANUAL.

In manual mode [MANUAL] (4/4)		▲	White balance	76
		◀	Iris or gain value	77
		▶	Shutter speed	77

### Set the AUTO/MANUAL/FOCUS switch to FOCUS.

In manual focus mode [FOCUS] (5/5)		◀▶	Manual focus adjustment	75
--	--	----	-------------------------	----

- The shaded operation icons are not displayed while recording.
- About switching between AUTO and MANUAL (→ 52)

## STD Recording mode

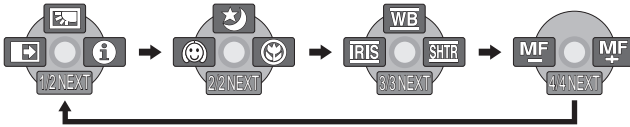

Icon	Direction	Function	Page	
(1/2)		▲	Backlight compensation	66
		◀	Fade	64
		▶	Help mode	46
(2/2)		▲	MagicPix	65
		◀	Soft skin mode	65
		▶	Tele macro	69

Set the AUTO/MANUAL/FOCUS switch to **MANUAL**.

In manual mode [MANUAL] (3/3)		▲	White balance	76
		◀	Iris or gain value	77
		▶	Shutter speed	77

Set the AUTO/MANUAL/FOCUS switch to **FOCUS**.

In manual focus mode [FOCUS] (4/4)		◀▶	Manual focus adjustment	75
---------------------------------------	--	----	-------------------------	----

- The shaded operation icons are not displayed while recording.
- About switching between AUTO and MANUAL (→ 52)

## HD/STD Playback mode





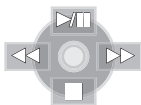

 (In motion picture playback)

### HD mode



### STD mode





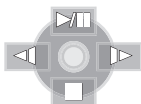

Icon	Direction	Function	Page
	▲	Playback/pause	79
	▼	Stop playback and show thumbnails	79
	◀	Rewind (during playback)	79
		Reverse slow/frame playback (during pause)	82
	▶	Fast forward (during playback)	79
		Forward slow/frame playback (during pause)	82

## HD Playback mode

 (In still picture playback)



Icon	Direction	Function	Page
	▲	Slide show start/pause	84
	▼	Stop playback and show thumbnails	84
	◀	Playback previous picture (during pause)	84
	▶	Playback next picture (during pause)	84

## Help mode

The help mode explains the operation icons displayed when the AUTO/MANUAL/FOCUS switch is set to AUTO in recording mode.

- ◇ Rotate the mode dial to select **●** or **□**.

### 1 Press the cursor button to display the icon.



### 2 Move the cursor button right to select [i].



### 3 Move the cursor button up, left or right to select the desired icon.

- ◇ HD mode



An explanation of the selected icon scrolls at the bottom of the screen.

- ◇ STD mode

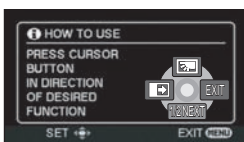

An explanation of the selected icon is displayed on the screen.

- The indication changes each time the cursor button is moved down.

## To exit the help mode

Press the MENU button or select [END] (HD mode)/[EXIT] (STD mode).



- When the help mode is used, functions cannot be set.
- When the help mode is used, motion pictures and still pictures cannot be recorded.

## Language selection

You can select the language on the screen display and the menu screen.

### 1 Press the MENU button, then select [LANGUAGE] and press the cursor button.



### 2 Select [English] and press the cursor button.

## Using the menu screen

Refer to "Menus and Indications" (→ 128) for information about the menus.

### 1 While stopped, press the MENU button.



The menu displayed differs depending on the position of the mode dial.

- Do not switch the mode dial when the menu is displayed.

### 2 Move the cursor button up or down in order to select the desired top menu **A**.



### 3 Move the cursor button right or press the cursor button.



The submenu **B** is displayed.

### 4 Move the cursor button up or down in order to select the submenu item.

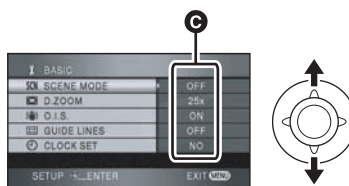

**C** Current settings on menus

### 5 Move the cursor button right or press the cursor button.

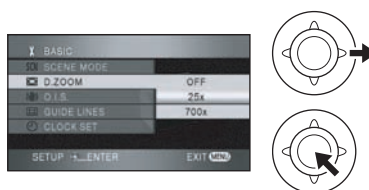

### 6 Move the cursor button up or down in order to select the desired item.



### 7 Press the cursor button to enter the selection.



### To get back to the previous screen

Move the cursor button left.

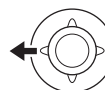

### To exit the menu screen

Press the MENU button.



- The menu screen does not appear during recording or playing. You cannot start other operations while the menu screen is displayed.

### Remote control operation

The menu screen transition is the same as when the buttons on the main unit are used.

#### 1 Press the MENU button.

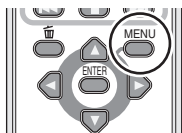

#### 2 Select a menu item.

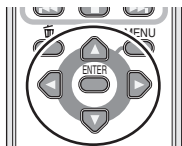

- Use the direction buttons (▲, ▼, ◀, ▶) and ENTER button in place of the cursor button on the main unit.

#### 3 Press the MENU button to exit the menu screen.

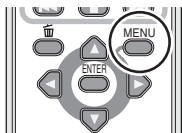

## Setting date and time

When the unit is turned on for the first time, a message asking you to set the date and time will appear.

- Move the cursor button to select [YES], press the cursor button and then perform steps 2 and 3 below to set the date and time.

◇ Rotate the mode dial to select **●** or **□**.

**1 Press the MENU button, then select [BASIC] → [CLOCK SET] → [YES] and press the cursor button.**

**2 Move the cursor button left or right to select the item to be set. Then, move the cursor button up or down to set the desired value.**



- The year will change as follows: 2000, 2001, ..., 2039, 2000, ...
- The 12-hour system is used to display the time.

**3 Press the cursor button to enter the selection.**

- The clock function starts at [00] seconds when the cursor button is pressed.
- Press the MENU button to finish the setting. Check the date and time displayed.



### Changing the date and time display style

Press the MENU button, then select [SETUP] → [DATE/TIME] → desired display style and press the cursor button.

- You can also show or change the date and time display by repeatedly pressing the DATE/TIME button on the remote control.

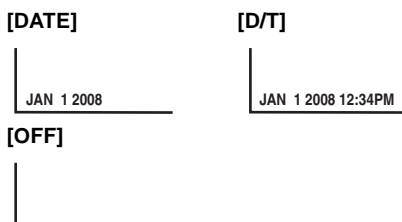

### Changing the display style

Press the MENU button, then select [SETUP] → [DATE FORMAT] → desired display style and press the cursor button.

Display style	Screen display
[Y/M/D]	2008. 1. 1
[M/D/Y]	JAN 1 2008
[D/M/Y]	1. 1.2008

- The date and time function are driven by a built-in lithium battery.
- Make sure to check the time before recording.
- If the time display becomes [- -], the built-in lithium battery has run down. Use the following steps to charge the battery.

### To recharge the built-in lithium battery:

Connect the AC adaptor or attach the battery to the unit, and the built-in lithium battery will be recharged. Leave the unit as it is for approx. 24 hours and the battery will save the date and time for approx. 6 months. (The battery is still being recharged even if the mode dial is set to OFF.)

- When you turn on the power for the first time after charging, a message asking you to set the date and time will appear. Select [YES] and set the date and time.

## Adjusting LCD monitor/viewfinder

### Adjusting the brightness and color level

- Press the MENU button, then select [SETUP] → [LCD SET] or [EVF SET] → [YES] and press the cursor button.
- Move the cursor button up or down to select the item to be adjusted. Then, move the cursor button left or right to make the adjustment.

- (HD mode) Move the cursor button to select the item to be adjusted. Then, press the center of the cursor button to set and then move the cursor button to make the adjustment.



The bar display moves.

- (HD mode) After adjustments are made if no operations are performed for about 2 seconds, the bar will disappear.
- Press the MENU button to exit the menu screen.

#### [LCD SET]

[BRIGHTNESS]:

Brightness of the LCD monitor

[COLOR]:

Color level of the LCD monitor

- When the viewfinder is extended and the LCD monitor is rotated by 180° towards the lens, the brightness and color level of the LCD monitor cannot be adjusted.

#### [EVF SET]

[BRIGHTNESS]:

Brightness of the viewfinder

- To adjust the brightness of the viewfinder, extend the viewfinder and close the LCD monitor to activate it.



- These settings will not affect the images actually recorded.
- The screen displayed on the LCD monitor is smaller in STD mode.

### **■ In order to increase the brightness of the entire LCD monitor**

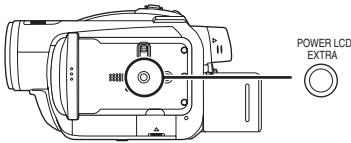
**Press the POWER LCD EXTRA button.**



The [  ] indication appears on the LCD monitor.

- Each time the POWER LCD EXTRA button is pressed, the indication changes by one setting in the following order: [  ] → [  ] → setting canceled (standard)
  - Press the POWER LCD EXTRA button if the surroundings are bright and the LCD monitor is difficult to see. The entire LCD monitor will become brighter than usual.
- 
- This will not affect the images to be recorded.
  - If you use the AC adaptor, the [  ] indication appears and the screen becomes brighter automatically when the power is turned on.

### **Adjusting the viewfinder field of view**

**Adjust the focus by sliding the eyepiece corrector knob.**

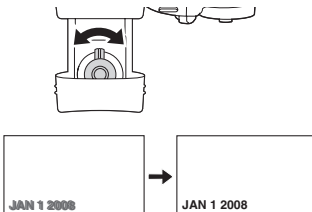

# Recording

## Before recording

First, format the SD card or the disc if one which has been used on another device is going to be used for the first time on this unit. (→ 93, 94) When the SD card or the disc is formatted, all of the recorded data is deleted. Once the data is deleted, it cannot be restored. Copy valuable data onto a PC or other device before proceeding with the formatting.

We recommend using HD Writer 2.0E for SX/SD to import data recorded on this unit. (→ 123)

## Basic camera positioning

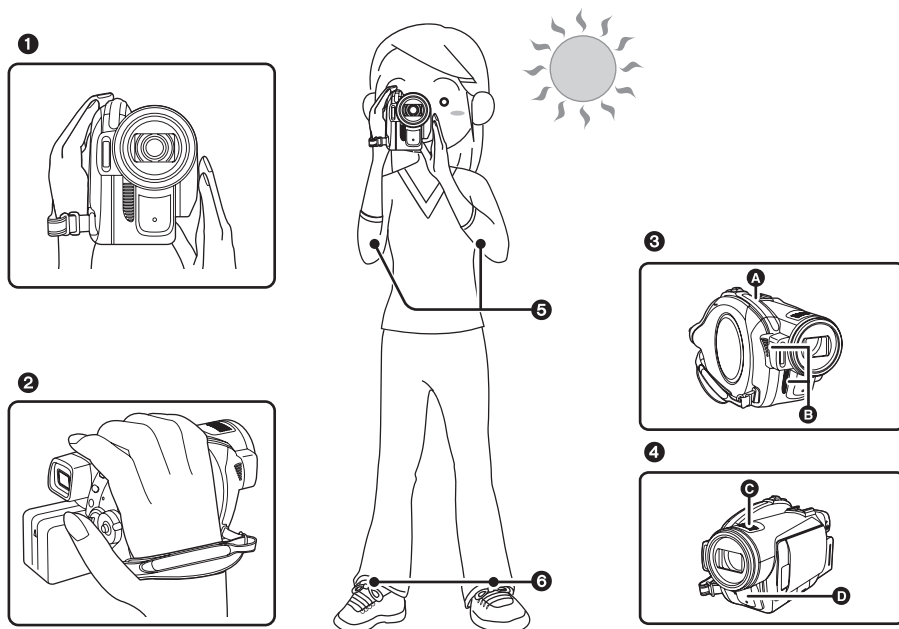

- 1 Hold the unit with both hands.
  - 2 Put your hand through the grip belt.
  - 3 Do not cover inlet **A** or outlet **B** of the cooling fan with your hand as it will prevent heat release. If heat builds up inside the unit, it could be damaged.
  - 4 Do not cover the microphones **C** or the sensors **D** with your hands.
  - 5 Keep your arms near your body.
  - 6 Separate your legs for better balance.
- When you are outdoors, record pictures with the sunlight behind you. If the subject is backlit, it will become dark in the recording.
  - When recording, make sure your footing is stable and there is no danger of colliding with another person or object.

## About auto mode

Set the AUTO/MANUAL/FOCUS switch to AUTO, color balance (white balance) and focusing will be adjusted automatically.

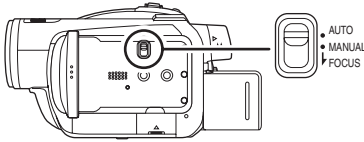

- Automatic white balance (→ 154)
- Auto focus (→ 155)

Depending on the brightness of the subject etc., the aperture and shutter speed are automatically adjusted for an optimum brightness.

(The shutter speed is adjusted to a maximum of 1/250 in recording mode.)

- Color balance and focus may not be adjusted automatically depending on light sources or scenes. If so, manually adjust these settings.
  - Scene mode setting (→ 74)
  - White balance setting (→ 76)
  - Shutter speed setting (→ 77)
  - Iris/gain value setting (→ 77)
  - Manual focus setting (→ 75)

## Auto Ground-directional Standby (AGS)

This function prevents unnecessary recording when you forget to pause recording and walk with the unit tilted upside down while recording continues.



- If the unit continues to be tilted upside down from the normal horizontal position while recording motion pictures, it is automatically set to recording pause.

### Turning the AGS function on/off

- ◇ Rotate the mode dial to select **●** or **□**.

Press the MENU button, then select [VIDEO] (HD mode) or [SETUP] (STD mode) → [AGS] → [ON] or [OFF] and press the cursor button.

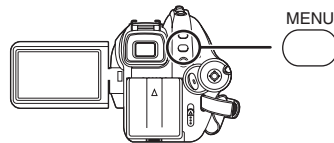

- This function's default setting is [OFF].
- The AGS function may activate and cause the unit to pause the recording if you are recording a subject right above or right below you. In these cases, set [AGS] to [OFF] then continue the recording.
- Use the recording start/stop button to pause the recording. The AGS function is only a backup function for when you forget to pause the recording.
- The time it takes the unit to be put into recording pause after being tilted upside down varies depending on the operating conditions.

## Recording motion pictures

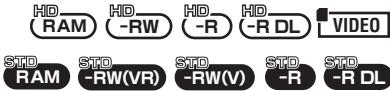

Record motion pictures to a disc or an SD card.

- Use an SD card that can be used for motion picture recording. (→ 29)
- This unit is compatible with the 16:9 aspect ratio of a wide-screen TV and images are recorded in high definition or conventional standard picture quality.

### 1 Rotate the mode dial to select or .

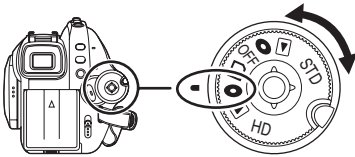

The lens cover opens automatically.

#### ◆ HD mode

- Records motion pictures in high definition picture quality on a disc or an SD card.

#### ◆ STD mode

- Records motion pictures in conventional standard picture quality on a disc.

### 2 Open the LCD monitor or extend the viewfinder.

### 3 Press the recording start/stop button to start recording.

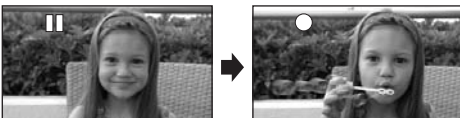
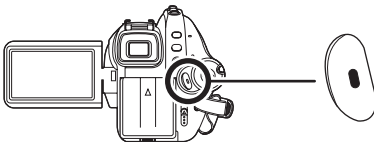



- The power will not turn off while recording motion pictures even if the LCD monitor is closed and the viewfinder is retracted.

### To end the recording

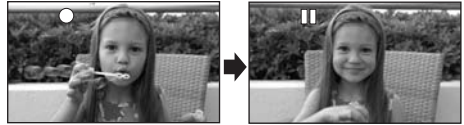
Press the recording start/stop button again to pause recording.



-  and  are red during recording. Do not move this unit until  is green.
- The images recorded between pressing the recording start/stop button to start recording and pressing it again to pause recording become one scene.
- When about 5 minutes have passed without any operation in recording pause, the unit automatically turns off to prevent the battery from running down. When you want to use the unit, turn it on again.  
This setting can also be set to [OFF]. (→ 131)

### ■ Screen indications in the disc recording mode (HD mode)



- A Recording mode**
- B Remaining time left for recording**  
(When the remaining time is less than 1 minute, [R0min] flashes red.)
- C Recording time elapsed**

- Maximum number of scenes (on one side if a disc): 999  
Maximum number of recordable scenes with different dates (on one side if a disc): 99  
(In some cases, scenes shot on the same day will be recorded with different dates (→ 83))  
When either of them reaches to the maximum limit, more scenes cannot be recorded.

- Discs or SD cards with more than the maximum scenes or dates cannot be used with this unit.
- Sound is recorded from the internal microphones on the top of this unit. Take care not to cover the microphone with your hand.
- Each time the unit is put into recording pause, the counter display will be reset to "0h00m00s".
- When recording motion pictures, do not remove the battery or disconnect the AC adaptor. Also do not remove the SD card while the card access lamp is lit. If you do either of the above, the scene recovery message is displayed and the recovery operation will begin when the SD card is next inserted or the power is turned back on. (→ 137)
- While "WRITING CONTROL DATA TO THE DISC. DO NOT SHAKE THE UNIT." is displayed, do not disconnect the AC adaptor or remove the battery as doing so may make the disc unusable.
- While motion picture recording is in progress, do not disconnect the AC adaptor or remove the battery. If you do, a repair disc message may be displayed when the power is turned back on. (→ 137)

The ACCESS/PC lamp lights immediately after recording finishes. While it lights, the disc is rotating and disc information is being recorded. If you shake the unit or swing it, the recorded images may be distorted so do not strongly shake or cause impact to it.

### ■ When recording stops suddenly during motion picture recording on an SD card

When using an SD card other than one that can be used for motion picture recording (→ 29), the recording may stop suddenly. At this time, the following message appears.

When motion pictures are to be recorded, use a Panasonic SD card or another SD card which can be used to record motion pictures. (→ 29)



**Even if you use an SD card that can be used for motion picture recording (→ 29), this kind of message may appear.**

The data on the card has been written many times and the data writing speed has reduced. We recommend formatting the SD card being used. (→ 94) When an SD card is formatted, all the data recorded on it will be deleted so copy valuable data to the PC prior to formatting. (→ 123) (When acquiring data recorded on this unit, we recommend using HD Writer 2.0E for SX/SD to acquire it. (→ 123))

## PRE-REC function

This prevents you missing a shot.



This allows recording of the pictures and sound to start approximately 3 seconds before the recording start/stop button is pressed so you can capture moments you would otherwise have missed.

◇ When the mode dial is set to **□** and an SD card is inserted in this unit.

**1** Open the LCD monitor or extend the viewfinder.

**2** Press the PRE-REC button.

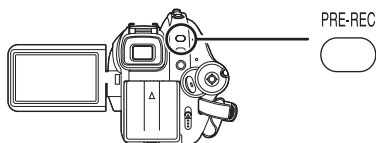

The **PRE-REC** indication appears.

- Aim this unit at the subject and position it securely.
- Recording of the pictures and sound starts approximately 3 seconds before the recording start/stop button is pressed.

**3** Press the recording start/stop button to start recording.

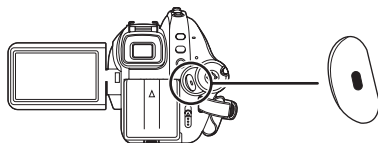

- There is no beep sound.
- After recording starts, the PRE-REC setting is canceled.

### To end PRE-REC

- PRE-REC is also ended if you press the PRE-REC button in PRE-REC.

- PRE-REC is canceled in the following cases.
  - If you operate the mode dial.
  - If you turn the unit off.
  - If you open the card slot cover.
  - If you press the MENU button.
  - In quick start standby mode.
- When the remaining time left for recording motion pictures is less than 1 minute, PRE-REC cannot be set.
- If you start recording less than 3 seconds after pressing the PRE-REC button, the PRE-REC function is not activated and the pictures are recorded normally.
- When the recording start/stop button is pressed, image shake and operation sound may be recorded.

## Recording modes and recordable time available for the motion picture



Switch the picture quality of the motion pictures to be recorded.

◇ Rotate the mode dial to select or .

Press the MENU button, then select [VIDEO] (HD mode) or [BASIC] (STD mode) → [REC MODE] → desired item and press the cursor button.

### ■ Approximate recordable time for a disc

#### HD mode

Disc type	HG	HN	HE
  	14 min	21 min	31 min
	26 min	40 min	60 min

**HG** (1920×1080):

Motion pictures can be recorded with the highest picture quality.

**HN** (1440×1080):

Motion pictures can be recorded with normal picture quality.

**HE** (1440×1080):

Motion pictures can be recorded for a longer time.

- The recordable times shown in the table are approximations.
- **The recording is in high definition picture quality no matter what recording mode is used to record.**
- This unit records in CBR in HG mode. CBR is an abbreviation for Constant Bit Rate. CBR recording does not vary the bit rate (amount of data in a fixed time).
- This unit records in VBR in HN/HE mode. VBR is an abbreviation for Variable Bit Rate. VBR recording automatically varies the bit rate (amount of data in a fixed time) depending on the subject being recorded. This means if a subject with sharp movements is recorded, the recording time is reduced.

#### STD mode

Disc type	XP	SP	LP
	18 min	37 min	1 h 15 min
  	18 min	37 min	1 h 14 min
	35 min	1 h 9 min	2 h 18 min

**XP**: Motion pictures can be recorded with the highest picture quality.

**SP**: Motion pictures can be recorded with normal picture quality.

**LP**: Motion pictures can be recorded for longer time.

- The recordable times shown in the table are approximations.
- **The recording is in standard picture quality no matter what recording mode is used to record.**
- This unit records in VBR (Variable Bit Rate) in XP/SP/LP mode. VBR recording automatically varies the bit rate (amount of data in a fixed time) depending on the subject being recorded. This means if a subject with sharp movements is recorded, the recording time is reduced.



## ■ Approximate recordable time for an SD card made by Panasonic

SD card memory	HG	HN	HE
256 MB	2 min	3 min	5 min
512 MB	5 min	7 min	10 min
1 GB	10 min	15 min	22 min
2 GB	20 min	30 min	45 min
4 GB	40 min	1 h	1 h 30 min
8 GB	1 h 20 min	2 h	3 h

- [HG]** (1920×1080):  
Motion pictures can be recorded with the highest picture quality.
- [HN]** (1440×1080):  
Motion pictures can be recorded with normal picture quality.
- [HE]** (1440×1080):  
Motion pictures can be recorded for longer time.

- The recordable times shown in the table are approximations.
- **The recording is in high definition picture quality no matter what recording mode is used to record.**
- This unit records in CBR (Constant Bit Rate) in HG mode. CBR recording does not vary the bit rate (amount of data in a fixed time).
- This unit records in VBR in HN/HE mode. VBR is an abbreviation for Variable Bit Rate. VBR recording automatically varies the bit rate (amount of data in a fixed time) depending on the subject being recorded. This means if a subject with sharp movements is recorded, the recording time is reduced.

### ● Recordable time using the battery (→ 33)

- 8 MB and 16 MB SD cards cannot be used for motion picture recording.
- If the write protection switch on the SD card is set to LOCK, it cannot be used for recording. (→ 29)
- If an SD card is recorded on or erased many times, it may no longer be possible to record motion pictures even if there is available memory on the SD card. In this case, after saving the data on PC, format the SD card.
- Mosaic-pattern noise may appear on a playback image in the following cases.
  - When there is a complicated pattern in the background
  - When the unit is moved too much or too fast
  - When a subject with sharp movements has been recorded (Particularly if it has been recorded in [HE] or [LP] mode.)
- Sound is recorded with the Dolby Digital.

## Recording still pictures (JPEG images) on an SD card

PHOTO

Record the still picture on an SD card.

- This number of recording pixels for still pictures is compatible with the 16:9 aspect ratio of a wide-screen TV. They are recorded at [1920×1080].
- Still pictures cannot be recorded in STD mode.

### 1 Rotate the mode dial to select or .

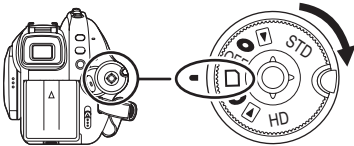

The lens cover opens automatically.

### 2 Open the LCD monitor or extend the viewfinder.

### 3 Press the PHOTO SHOT button halfway in order to adjust the focus. (For auto focus only)

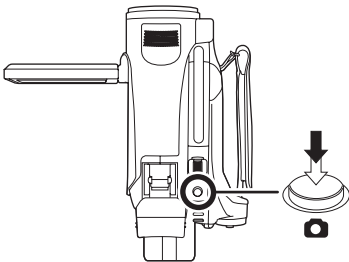

The shutter speed and the iris/gain value are fixed and the unit focuses on the subject automatically.

- If you set [O.I.S.] (→ 69) to [ON], then the image stabilizer function will be more effective. ([MEGA] 

### Focus indication:

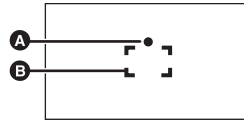

- A** Focus indication
- B** Focus area (area inside brackets)

○ (The white lamp flashes.):

Focusing

● (The green lamp lights up.):

When in focus

No mark:

When focusing is unsuccessful.

### 4 Press the PHOTO SHOT button fully to take the picture.

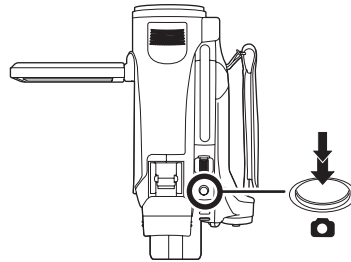

- In order to take better still pictures, the screen will brighten when the PHOTO SHOT button is fully pressed.

### To record still pictures clearly

- When zooming in on the subject with a magnification of 4× or higher, it is difficult to reduce the slight shaking from holding this unit by hand. We recommend decreasing the zoom magnification and approaching the subject when recording.
- When recording still pictures, hold the unit firmly with your hands and keep your arms stationary at your side so as not to shake the unit.
- You can record stable pictures without shaking by using a tripod and the remote control.

- For information about the number of recordable still pictures on an SD card (→ 61)

- The sound cannot be recorded.
- If the write protection switch on the SD card is set to LOCK, it cannot be used for recording.
- The PHOTO SHOT button on the remote control cannot be pressed halfway.
- If the [PICT.QUALITY] is set to [MOSAIC], mosaic-pattern noise may appear on a playback image depending on the picture content.
- While this unit accesses the SD card (▶ is displayed/the access lamp is lit), do not perform the following operations. The SD card or the recorded data may be damaged.
  - Turn the unit off.
  - Open the card slot cover and remove the SD card.
  - Operate the mode dial.
- Other products may degrade or not play back still pictures recorded on this unit.
- The edges of still pictures recorded on this unit with a 16:9 aspect ratio may be cut at printing. Check the printer or photo studio before printing.

### ■ About the screen indications when the PHOTO SHOT button is pressed halfway

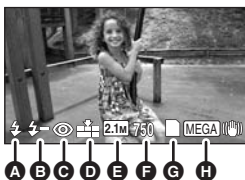

- A** Flash (→ 67)
- B** Flash level (→ 68)
- C** Red eye reduction (→ 68)
- D** Quality of still pictures (→ 60)
- E** Size of still pictures
- F** Remaining number of still pictures (Flashes in red when [0] appears.)
- G** Card indication (→ 132)
- H** MEGA optical image stabilizer (→ 58)

### ■ About the focus indication

- The focus indication indicates the status of the auto focus.
- The focus indication does not appear in manual focus mode.
- Focus on a subject manually when it is not easily focused. (→ 75)
- You can record still pictures on the card even if the focus indication does not appear, but pictures may be recorded without being focused.
- The focus indication does not appear or has difficulty displaying in the following cases.
  - When the zoom magnification is high.
  - When the unit is shaken.
  - When the subject is moving.
  - When the subject stands in front of a light source.
  - When close subjects and far subjects are included in the same scene.
  - When the scene is dark.
  - When there is a bright part in the scene.
  - When the scene is filled with only horizontal lines.
  - When the scene lacks contrast.
  - When recording motion pictures.
  - When the MagicPix function is used.
  - When PRE-REC is used.

### ■ Concerning the focusing area

When there is a contrasting object ahead or behind the subject in the focus area, the subject may not be focused. If so, move the contrasting object out of the focus area.

If it is still difficult to focus, adjust the focus manually.

- The focusing area is not displayed when the digital zoom (more than approx. 10×) is used.

### Switching the shutter sound on/off

You can add a shutter sound when recording still pictures.

**Press the MENU button, then select [PICTURE] → [SHTR SOUND] → [ON] or [OFF] and press the cursor button.**

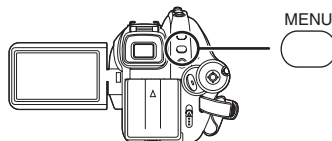

- This function's default setting is [ON].
- This function does not work during motion picture recording.

**About simultaneous recording  
(recording still pictures while  
recording motion pictures)**

You can record still pictures on an SD card even while recording motion pictures on SD card and/or disc.

**While recording motion pictures, press the PHOTO SHOT button fully (press to the bottom) to take the picture.**

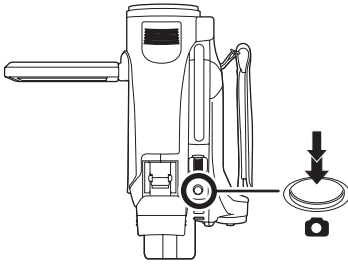

- The PHOTO SHOT button cannot be pressed halfway in the simultaneous recording.
- The screen indications that appear when the PHOTO SHOT button is pressed halfway will be displayed.
- The picture quality is different from normal still picture recording because priority is given to the motion picture recording. We recommend pausing the motion picture recording to record a still picture with better picture quality.
- Still pictures cannot be recorded in STD mode.

**Number of pixels and picture quality for still picture recording**



**PHOTO**

**Picture quality**

Selecting the picture quality.

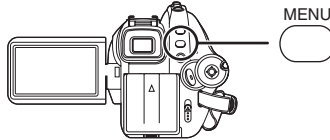

**Press the MENU button, then select [PICTURE] → [PICT.QUALITY] → desired item and press the cursor button.**





-  : Still pictures with a high picture quality are recorded.
-  : Priority is given to the number of still pictures recorded. Still pictures are recorded in normal picture quality.

## Approximate Number of Recordable Pictures on an SD Card

### Picture quality and number of recordable pictures

Picture size	2.1m (1920×1080)	
Picture quality		
8 MB	4	6
16 MB	10	17
32 MB	20	32
64 MB	47	74
128 MB	94	150
256 MB	200	320
512 MB	410	640
1 GB	820	1290
2 GB	1670	2630
4 GB	3290	5160
8 GB	6690	10520



- The number of recordable pictures depends on whether [] and [] are used together and on the subject being recorded.
- The numbers shown in the table are approximations.

## Recording functions

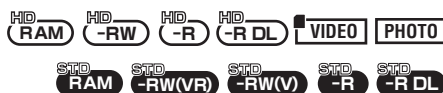
### Zoom in/out function



The maximum optical zoom ratio is 10×.

- ◇ Rotate the mode dial to select  or .

Move the zoom lever.

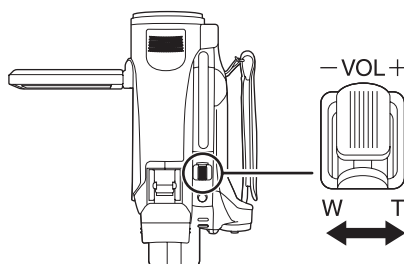

#### T side:

Close-up recording (zoom in)

#### W side:

Wide-angle recording (zoom out)

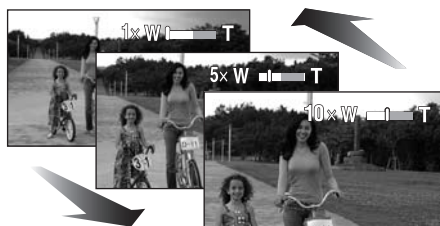

- If you take your finger off the zoom lever during zoom operation, the operation sound may be recorded. When returning the zoom lever to the original position, move it quietly.
- When zooming in while holding this unit by hand, we recommend using the image stabilizer function. (→ 69)
- When distant subjects are brought closer, they are focused at about 1.2 m (3.9 feet) or more.

- When the zoom magnification is 1×, this unit can focus on a subject approx. 4 cm (1.6") away from the lens. (Macro function)
- The zoom speed varies depending on the range over which the zoom lever is moved. (The zoom speed does not vary when operating with the remote control.)
- If the zoom lever is pushed to the end, you can zoom from 1× up to 10× in as fast as approx. 2.3 seconds.
- When the zoom speed is high, the subject may not be focused easily.

### Digital zoom function

If the zoom magnification exceeds 10×, then the digital zoom function will be activated. The maximum magnification provided by the digital zoom can be selected.

**Press the MENU button, then select [BASIC] (HD mode) or [ADVANCED] (STD mode) → [D.ZOOM] → desired item and press the cursor button.**

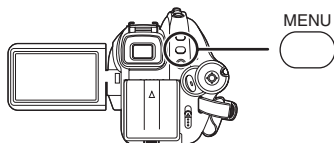

[OFF]: Optical zoom only (Up to 10×)

[25×]: Up to 25×

[700×]: Up to 700×

- If [25×] or [700×] is selected, the digital zoom range is displayed in blue while zooming.

- The larger the digital zoom magnification, the more the image quality is degraded.

### About using the zoom microphone function

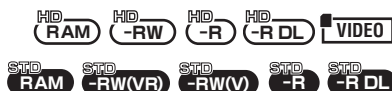

The zoom microphone is linked to the zooming operation so that far-away sounds with a tele-shot and close-up sounds with a wide-angle shot are recorded more clearly.

**Press the MENU button, then select [VIDEO] (HD mode) or [ADVANCED] (STD mode) → [ZOOM MIC] → [ON] and press the cursor button.**

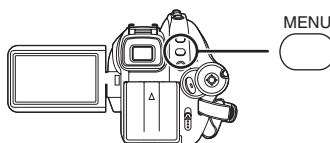

- The stereo effect will be reduced with tele-shots.

## Recording Yourself



You can record yourself while viewing the LCD monitor. You can record persons in front of the unit while showing them the image.

- ◇ Rotate the mode dial to select **●** or **□**.

Rotate the LCD monitor towards the lens side.

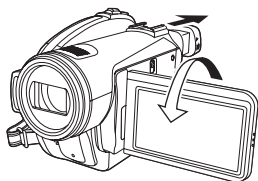

The image is horizontally flipped as if you see a mirror image. (However the image recorded is the same as a normal recording.)

- Extend the viewfinder to see the picture while recording.

- When the LCD monitor is rotated towards the lens side, the icon will not be displayed even if you press the cursor button.
- Only some indications will appear on the screen. When [ ] appears, return the direction of the LCD monitor to normal position and check the warning/alarm indication. (→ 135)

## Intelligent contrast control

This is for recording both bright and dark parts clearly at the same time.



This brightens parts that are in the shadow and difficult to see and stops white saturation in bright parts.

- ◇ Rotate the mode dial to select **●** or **□**.

- 1 Press the cursor button. Then move the cursor button down to display the icon shown in the illustration.



- 2 Move the cursor button up to select [ ].



### To cancel intelligent contrast control

Select [ ] again.

- If there are extremely dark or bright parts or the brightness is insufficient, the effect may not be clear.
- If you turn off the power or operate the mode dial, the intelligent contrast control is canceled.

## Fade in/fade out function

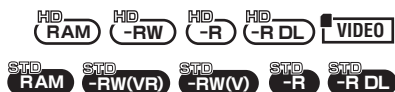

### Fade in:

The image and audio gradually appear.

### Fade out:

The image and audio gradually disappear.

- ◇ Rotate the mode dial to select **VIDEO** or **ADVANCED**.

- 1 Press the cursor button. Then move the cursor button down to display the icon shown in the illustration.



- 2 Move the cursor button left to select **[FADE]**.



- 3 Press the recording start/stop button. (Fade in)



When you start recording, the image/audio gradually appears.

- 4 Press the recording start/stop button. (Fade out)



The image/audio gradually disappears. After the image/audio completely disappears, recording stops.

- After recording, the fade setting is canceled.

### To cancel fading

Select **[FADE]** again.

### To select the color for fade in/out

The color which appears in fading pictures can be selected.

Press the **MENU** button, then select **[VIDEO]** (HD mode) or **[ADVANCED]** (STD mode) → **[FADE COLOR]** → **[WHITE]** or **[BLACK]** and press the cursor button.

- If you turn off the power, the fade function is canceled.
- While the fade in/fade out function is selected, it takes several seconds to display the image when you start recording. It also takes several seconds to pause recording.
- The thumbnails of scenes recorded using fade in become black (or white).



## MagicPix function

This allows recording in dark locations.



This function allows you to record color images in very low light situations. (Minimum required illumination: approx. 1 lx)

Attach this unit to a tripod, and you can record images free from vibration.

- Recorded scene is seen as if frames were missed.

◇ Rotate the mode dial to select or .

- Press the cursor button. Then move the cursor button down to display the icon shown in the illustration.

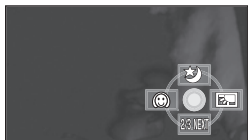

- Move the cursor button up to select [].

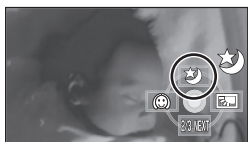

### To cancel the MagicPix function

Select [] again.

- The focus indication does not appear even if the PHOTO SHOT button is pressed halfway.
- In darker areas, auto focus may focus a bit slower. This is normal. If there is difficulty focusing with auto focus, manually adjust the focus.
- The MagicPix function makes the signal charging time of CCD up to approximately 30×

longer than usual, so that dark scenes can be recorded brightly. For this reason, bright dots that are usually invisible may be seen, but this is not a malfunction.

- If you turn off the power or operate the mode dial, the MagicPix function is canceled.
- If set in a bright place, the screen may become washed out for a while.

## Soft skin mode

This makes skin colors appear softer for a more attractive appearance.

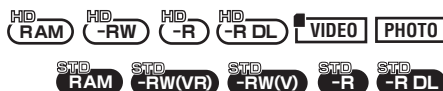

This is more effective if you record a subject more closely from the torso up.

◇ Rotate the mode dial to select or .

- Press the cursor button. Then move the cursor button down to display the icon shown in the illustration.

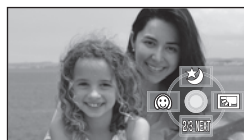

- Move the cursor button left to select [].



### To cancel the soft skin mode

Select [] again.

- If the background or anything else in the scene has colors similar to the skin color, they will also be smoothed.
- If the brightness is insufficient, the effect may not be clear.

- If you record a person in the distance, the face may not be recorded clearly. In this case, cancel soft skin mode or zoom in on the face (close-up) to record.

### Backlight compensation function

This is for preventing a backlit subject from being darkened.



Use this function when the light is emanating from behind the subject and the subject appears dark.

- ◆ Rotate the mode dial to select **●** or **□**.

**1 Press the cursor button. Then move the cursor button down to display the icon shown in the illustration.**

- ◆ HD mode



- ◆ STD mode



**2 (HD mode) Move the cursor button right to select [☀].**



**(STD mode) Move the cursor button up to select [☀].**



- The image on the screen will become brighter.

### To return to normal recording

Select [☀] again.

- If you turn off the power or operate the mode dial, the backlight compensation function is canceled.

### Self-timer recording

PHOTO

You can record still pictures on an SD card using the timer.

- ◆ Rotate the mode dial to select **●** or **□**.

**1 Press the cursor button. Then move the cursor button down to display the icon shown in the illustration.**

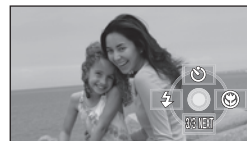

**2 Move the cursor button up to select [⌚].**



- Each time the cursor button is pressed up, the indication changes by one setting in the following order: [⌚<sub>10</sub>] → [⌚<sub>2</sub>] → setting canceled

⌚<sub>10</sub>: Starts recording after 10 seconds

⌚<sub>2</sub>: Starts recording after 2 seconds

### 3 Press the PHOTO SHOT button.

A still picture is recorded after the [⌚<sub>10</sub>] or [⌚<sub>2</sub>] display and the recording lamp flashes for the time which has been set.

- After recording, the self-timer is canceled.
- If you press the PHOTO SHOT button halfway and then fully in auto focus mode, the subject is focused when the button is pressed halfway.
- When you press the PHOTO SHOT button fully in auto focus mode, the subject is focused just before recording.

#### To stop the timer midway through

Press the MENU button. (The self-timer setting is canceled.)

- The self-timer is canceled if the power is turned off or the mode dial is operated.
- The self-timer standby mode is canceled when you press the recording start/stop button to start motion picture recording. Even if you press the recording start/stop button while the self-timer is counting down, motion picture recording is not possible.
- Depending on the time taken to bring the subject into focus, the recording may take longer than set to start.
- Setting the self-timer to [⌚<sub>2</sub>] is a good way to prevent image shake when the PHOTO SHOT button is pressed while using a tripod etc.

## Built-in flash

PHOTO

Use the built-in flash in order to record still pictures in dark places.

◇ Rotate the mode dial to select  or .

### 1 Press the cursor button. Then move the cursor button down to display the icon shown in the illustration.

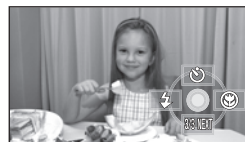

### 2 Move the cursor button left to select [⚡].

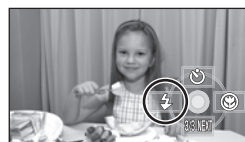

- Each time the cursor button is pressed left, the indication changes by one setting in the following order: [FLASH ON] → [FLASH AUTO] → [FLASH OFF]
- When the PHOTO SHOT button is pressed halfway, the flash indicator will appear in the bottom left corner of the screen.

[FLASH ON]: 

[FLASH AUTO]: 

[FLASH OFF]: 

- When [FLASH AUTO] is set, the ambient brightness is automatically detected, and the flash will activate only when necessary. (If the flash is not necessary, the [⚡A] indicator will not appear when the PHOTO SHOT button is pressed halfway.)
- This function's default setting is [FLASH AUTO].

### 3 Press the PHOTO SHOT button.

The flash is activated and the picture will be recorded.

### When the flash is not used

Set the flash to [FLASH OFF].

- Do not block the flash with your hand or by other means.
- The unit automatically determines if the flash is necessary even when it has been set to [FLASH OFF] by detecting the ambient brightness. (If it determines that the flash is necessary, the [☼] indication lights up in red when the PHOTO SHOT button is pressed halfway.)
- If the [⚡] indication etc. flashes or is not displayed when the PHOTO SHOT button is pressed halfway, the flash is not activated.
- The available range of the flash is approx. 1 m to 2.5 m (3.3 feet to 8.2 feet) in dark places. Pictures will appear dark or reddish when they are recorded by using the flash at distances greater than 2.5 m (8.2 feet).
- Using the flash fixes a shutter speed of 1/750 or faster to 1/500.
- The picture may become out of focus in dark places. If so, adjust the focus manually.
- The picture may appear dark if the flash is lit in front of a white background.
- A conversion lens (optional) can block the flash and may cause a vignetting effect.
- Set the flash to [FLASH OFF] where using a flash is prohibited.
- If the flash is activated a large number of times, it may take longer to charge it.

### Red eye reduction function

Reduces the phenomena where human eyes become red from flashes.

**Press the MENU button, then select [PICTURE] → [RED EYE] → [ON] and press the cursor button.**

### To cancel the red eye reduction function

Press the MENU button, then select [PICTURE] → [RED EYE] → [OFF] and press the cursor button.

- The flash is activated 2 times. Do not move until the second flash is finished.
- Use this when you take pictures of people in dark places.

- Red eye phenomenon may appear depending on the recording conditions.

### To adjust the brightness of the flash

**Press the MENU button, then select [PICTURE] → [FLASH LEVEL] → desired item and press the cursor button.**

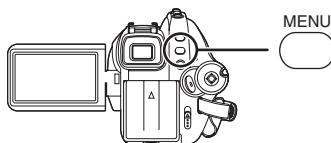

[⚡-]: If the brightness is too high.

[⚡±0]: In normal recording

[⚡+]: If the brightness is insufficient.

### Using the flash VW-FLH3 (optional)

- The flash permits still picture recording in a dark place 2.5 m (8.2 feet) or more distant from the subject. The available range of the flash is approx. 1 m to 4 m (3.3 feet to 13.1 feet).
- The [⚡] or [⚡A] indication appears only when the PHOTO SHOT button is pressed halfway.
- The flash setting cannot be changed when the power switch on the flash is set to [ON] or [AUTO].
- The optional flash and the built-in flash cannot be used simultaneously.
- The brightness of the flash cannot be adjusted.
- The shutter speed, iris/gain, and white balance become fixed.
- Using the flash outdoors or with backlight or other bright conditions may result in white blotches (color blotches) on the pictures. If so, either adjust the iris manually or use the backlight compensation function, without using the flash.
- Carefully read the operating instructions for the flash.

## Tele macro function

This is for close-ups bringing only what you want to record into focus.



By focusing only on the subject and blurring the background, the image can be impressive.

The unit can focus on the subject at a distance of approx. 50 cm (20").

◇ Rotate the mode dial to select or .

- 1 Press the cursor button. Then move the cursor button down to display the icon shown in the illustration.

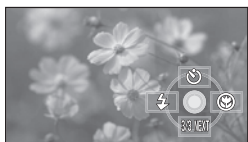

- 2 Move the cursor button right to select .



- If the magnification is 10× or less, then it is automatically set to 10×.

### To cancel the tele macro function

Select again.

- If a sharper focus cannot be achieved, adjust the focus manually. (→ 75)
- In the following cases, the tele macro function is canceled.
  - The zoom magnification becomes lower than 10×.
  - The power is turned off or the mode dial is operated.

## Image stabilizer function

This is for reducing image shakes during recording.

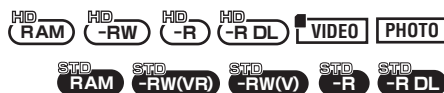

Reduces the image shaking due to hand movement when recording.

◇ Rotate the mode dial to select or .

- Press the MENU button, then select [BASIC] (HD mode) or [ADVANCED] (STD mode) → [O.I.S.] → [ON] and press the cursor button.

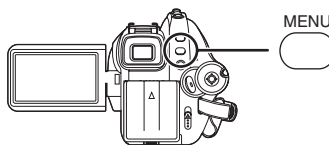

### To cancel the image stabilizer function

Press the MENU button, then select [BASIC] (HD mode) or [ADVANCED] (STD mode) → [O.I.S.] → [OFF] and press the cursor button.

- This function's default setting is [ON].
- In still picture recording mode, pressing the PHOTO SHOT button halfway increases the effect of the image stabilizer function. (MEGA optical image stabilizer)
- When a tripod is used, we recommend that you turn the image stabilizer off.
- In the following cases, the image stabilizer function may not work effectively.
  - When the digital zoom is used
  - When the unit is shaken greatly
  - When you record a moving subject while tracking it
  - When the conversion lens is used

## Guide line function

This is for viewing the slope and the balance of the image while recording or playing back.



You can check if the image is level while recording or playing back motion pictures and still pictures. The function can also be used to estimate the balance of the composition.

### HD mode

- ◇ Rotate the mode dial to select or or rotate the mode dial to and then select the [] or [] tab. (→ 79)

Press the MENU button, then select [BASIC] or [PLAY SETUP] → [GUIDE LINES] → desired item and press the cursor button.

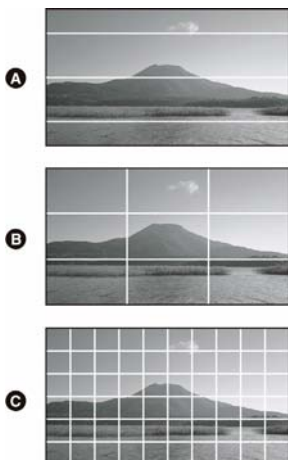

- A [HORIZONTAL]
- B [GRID1]
- C [GRID2]

### To cancel the guide line function

Press the MENU button, then select [BASIC] or [PLAY SETUP] → [GUIDE LINES] → [OFF] and press the cursor button.

### STD mode

- ◇ Rotate the mode dial to select . Press the MENU button, then select [BASIC] → [GUIDE LINES] → [ON] and press the cursor button.

### To cancel the guide line function

Press the MENU button, then select [BASIC] → [GUIDE LINES] → [OFF] and press the cursor button.

- The guide lines do not appear on the images actually recorded.
- The guidelines are not displayed while rotating the LCD monitor forward to record yourself.

## Wind noise reduction function

This is for reducing the wind noise coming into the microphone when recording.

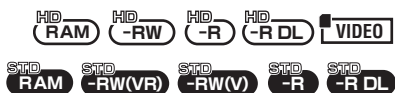

- ◇ Rotate the mode dial to select **VIDEO** or **ADVANCED**.

Press the MENU button, then select [VIDEO] (HD mode) or [ADVANCED] (STD mode) → [WIND CUT] → [ON] and press the cursor button.

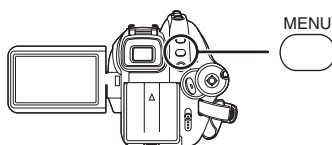

### To cancel the wind noise reduction function

Press the MENU button, then select [VIDEO] (HD mode) or [ADVANCED] (STD mode) → [WIND CUT] → [OFF] and press the cursor button.

- This function's default setting is [ON].
- The wind noise reduction depends on the wind strength. (The stereo effect may be reduced if this function is activated in strong winds. However, the stereo effect is automatically restored when then the wind weakens.)

## Microphone level

This is for adjusting the microphone input level.



When recording, the input level from the built-in microphones and the external microphone terminal can be adjusted.

- ◇ Rotate the mode dial to select **VIDEO** or **ADVANCED**.

- 1 Press the MENU button, then select [VIDEO] → [MIC LEVEL] → [SET+AGC] or [SET] and press the cursor button.

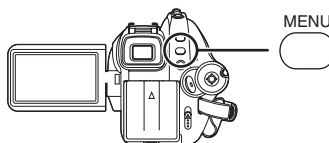

AGC: Auto Gain Control

[AUTO]: AGC is activated, and the recording level is adjusted automatically.

[SET+AGC]: The desired recording level can be set. AGC will also be activated to reduce the amount of sound distortion.

[SET]: AGC is not activated and so natural recording can be performed.

- 2 Move the cursor button left or right to adjust the microphone input level.



- A** Left
- B** Right
- C** Microphone input level

- A gain value for each of the 2 built-in microphones is displayed. (The input level of the microphones cannot be set individually.)

**3 Press the cursor button to set and then press the MENU button to finish the setting.**

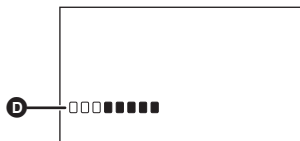

- Microphone input level meter
- Microphone input level meter is displayed on the screen.

**To return to automatic setting**

Press the MENU button, then select [VIDEO] → [MIC LEVEL] → [AUTO] and press the cursor button.

- Adjust the gain value so that the last 2 bars of the microphone input level on the center of the screen are not red. (Otherwise, the sound is distorted.) Select a lower setting for gain value or set [MIC LEVEL] to [AUTO].
- The microphone input level meter displays the microphone input level for the built-in microphone with the larger volume.
- When [ZOOM MIC] is [ON], the volume will be different depending on the zoom rate. Set [ZOOM MIC] to [OFF] or set the microphone input level after adjusting the zoom rate. (→ 62)

**Zebra display**  
Displays portions of the image that may be overexposed.



Parts where white saturation (color saturation) is likely to occur (extremely brightly lit or shiny parts) are displayed with diagonal lines (zebra pattern).

- Rotate the mode dial to select or .

**Press the MENU button, then select [ADVANCED] → [ZEBRA] → [ON] and press the cursor button.**

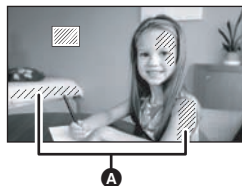

- Zebra pattern
- You can record an image with little white saturation if you manually adjust the shutter speed or brightness (iris/gain) (→ 77).

**To cancel the zebra display**

Press the MENU button, then select [ADVANCED] → [ZEBRA] → [OFF] and press the cursor button.

- The zebra pattern does not appear on the images actually recorded.



## Color bar

This is for displaying a color bar to check the color tone.



This unit displays a 7 color bar which is useful for adjusting the picture quality of the TV or the external monitor.

- ◆ Rotate the mode dial to select  or .

Press the MENU button, then select [ADVANCED] → [COLOR BAR] → [ON] and press the cursor button.

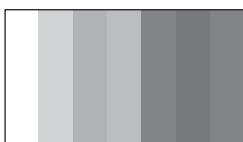

### To cancel the color bar



Press the MENU button, then select [ADVANCED] → [COLOR BAR] → [OFF] and press the cursor button.

- This function is canceled when the power is turned off.
- The icon will not be displayed even if you press the cursor button.

## Auto slow shutter mode



You can record bright pictures even in dark places by slowing the shutter speed.

- ◆ Rotate the mode dial to select  or .

Press the MENU button, then select [ADVANCED] → [AUTO SLOW SHTR] → [ON] and press the cursor button.

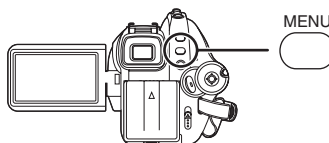

- When auto slow shutter mode is selected, the shutter speed is adjusted between 1/30 and 1/250 depending on the surrounding brightness.
- When adjusting the shutter speed manually, it can be adjusted between 1/30 and 1/8000. (→ 77)

### To cancel the auto slow shutter mode

Press the MENU button, then select [ADVANCED] → [AUTO SLOW SHTR] → [OFF] and press the cursor button.

- If [AUTO SLOW SHTR] is set to [OFF], then the shutter speed will be set between 1/60 and 1/250. (When adjusting the shutter speed manually, it can be adjusted between 1/60 and 1/8000.)
- This function's default setting is [ON].
- If the scene is low in brightness or contrast, the subject may not be focused in on.
- When the shutter speed becomes 1/30, the screen display may appear to have frames missing and afterimages may appear.

## Manual recording functions

### Scene mode

This is for recording in various situations.



When you record images in different situations, this mode automatically sets optimum shutter speeds and apertures.

◇ Rotate the mode dial to select or .

**1 Set the AUTO/MANUAL/FOCUS switch to MANUAL.**

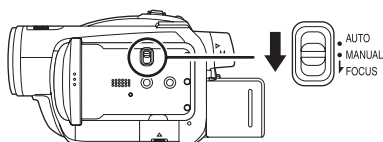

**2 Press the MENU button, then select [BASIC] → [SCENE MODE] desired item and press the cursor button.**

#### [] Sports

Used to record fast action.

#### [] Portrait

To make people stand out against the background

#### [] Low light

Improved image quality in low light situations.

#### [] Spotlight

Improved quality when subject is brightly illuminated.

#### [] Surf & snow

Improved image quality when shooting on beaches or snowy locations.

### To cancel the scene mode function

Press the MENU button, then select [BASIC] → [SCENE MODE] → [OFF] and press the cursor button.

- You can also cancel the scene mode function by setting the AUTO/MANUAL/FOCUS switch to AUTO.

### Sports mode

- For slow-motion playback or playback pause of recorded pictures, this mode helps diminish camera shake.
- During normal playback, the image movement may not look smooth.
- Avoid recording under fluorescent light, mercury light or sodium light because the color and brightness of the playback image may change.
- If you record a subject illuminated with bright light or a highly reflective subject, vertical lines of light may appear.
- If the brightness is insufficient, the sports mode does not function. The [] display flashes.
- If this mode is used indoors, the screen may flicker.

### Portrait mode

- If this mode is used indoors, the screen may flicker. If so, change the scene mode setting to [OFF].

### Low light mode

- Extremely dark scenes may not be able to be recorded finely.

### Spotlight mode

- If the recording subject is extremely bright, the subject may become washed out and the periphery extremely darkened.

### Surf & snow mode

- If the subject is extremely bright, the recorded image may become washed out.

## Manual focus adjustment



If auto focusing is difficult due to the conditions, then use manual focus.

◇ Rotate the mode dial to select **●** or **□**.

**1** (When MF assist function is used)  
(HD mode only)

Press the MENU button, then select [ADVANCED] → [MF ASSIST] → [ON] and press the cursor button.

**2** Set the AUTO/MANUAL/FOCUS switch to MANUAL.

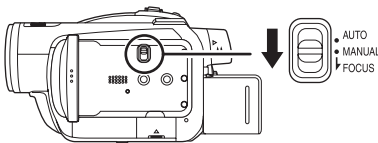

**3** Move the switch down and set it to FOCUS position.



The manual focus indication [MF] and the icon shown in the illustration appear.

**4** Move the cursor button left or right to bring the subject into focus.



### To restore to the automatic adjustment

Press the AUTO/MANUAL/FOCUS switch down again to the FOCUS position.

- You can also restore the auto focusing by setting the AUTO/MANUAL/FOCUS switch to AUTO.
- The subject may not be in focus when zoomed in if focusing with a wide angle. First, zoom in on the subject, and then focus on it.

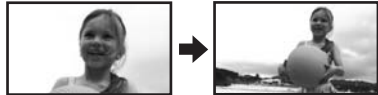

### About the MF assist function (HD mode only)

The center of the screen is enlarged during manual focus adjustment. This allows you to focus on the subject more easily.

The normal screen returns approximately 2 seconds after you finish bringing the subject into focus.

- The center of the screen is not enlarged if [MF ASSIST] is set to [OFF].
- MF assist does not work if the zoom magnification is more than 10×.
- The part of the screen that is enlarged is not enlarged on the image actually recorded.
- The zebra pattern does not appear on the part of the screen that is enlarged when [ZEBRA] is [ON].

## White balance

This is for recording in natural colors.



The automatic white balance function may not reproduce natural colors depending on the scenes or lighting conditions. If so, you can adjust the white balance manually.

◇ Rotate the mode dial to select **◉** or **◻**.

### 1 Set the AUTO/MANUAL/FOCUS switch to MANUAL.



The icon shown in the illustration is displayed automatically.

### 2 Move the cursor button up to select [WB].



### 3 Move the cursor button left or right to select the white balance mode.



[AWB]: Auto white balance adjustment

[◉]: Indoor mode (for recording under incandescent lamps)

- Incandescent lights, halogen lamps

[◻]: Outdoor mode

- Outdoors under a clear sky

[☒]: Manual adjustment mode

- Mercury-vapor lamps, sodium lamps, some fluorescent lights
- Lights used for wedding receptions at hotels, stage spotlights in theatres
- Sunrise, sunset etc.

### To restore to the automatic adjustment

Set the white balance mode to [AWB].

- You can also restore the automatic adjustment by setting the AUTO/MANUAL/FOCUS switch to AUTO.

### To set the white balance manually

#### 1 Select [☒], fill the screen with a white subject.

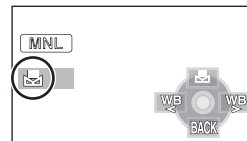

#### 2 Move the cursor button up to select [WB].

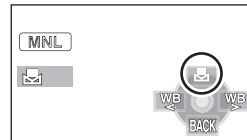

- When the [☒] display stops flashing, the setting is complete.
- If the [☒] display continues flashing, the white balance cannot be set because it is too dark etc. In this case, use the automatic white balance.

## White balance sensor

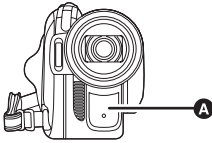

The white balance sensor **A** detects the type of light source during recording.

Do not cover the white balance sensor during recording, or it may not function properly.

## Black balance adjustment

This is one of the 3CCD system functions that automatically adjusts the black when the white balance is set in the manual adjustment mode. When the black balance is adjusted, the screen will temporarily be black. (The black balance cannot be adjusted manually.)

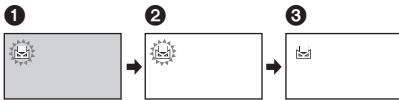

- 1 Black balance adjustment in progress. (Flashes.)
- 2 White balance adjustment in progress. (Flashes.)
- 3 Adjustment completed. (Lights up.)

- When the [WB] display flashes, the manual white balance previously adjusted is stored. Whenever recording conditions change, re-set the white balance for correct adjustment.
- When setting both the white balance and the iris/gain, set the white balance first.

## Manual shutter speed/aperture adjustment



### Shutter Speed:

Adjust it when recording fast-moving subjects.

### Aperture:

Adjust it when the screen is too bright or too dark.

- ◇ Rotate the mode dial to select **●** or **□**.

### 1 Set the AUTO/MANUAL/FOCUS switch to MANUAL.



The icon shown in the illustration is displayed automatically.

### 2 Move the cursor button left or right to select [IRIS] (aperture) or [SHTR] (shutter speed).



### 3 Move the cursor button left or right to make the adjustment.



### A Shutter speed:

#### HD mode:

1/30 to 1/8000

#### STD mode:

1/60 to 1/8000

- The shutter speed closer to 1/8000 is faster.
- (HD mode) If [AUTO SLOW SHTR] is set to [OFF], then the shutter speed will be set between 1/60 and 1/8000.

### **B** Iris/Gain value:

**CLOSE** → (F16 to F2.0) → **OPEN** → (0dB to 18dB)

- Value closer to [CLOSE] darken the image.
- Value closer to [18dB] brighten the image.
- When the iris value is adjusted to brighter than [OPEN], it changes to the gain value.

---

### **To restore to automatic adjustment**

Set the AUTO/MANUAL/FOCUS switch to AUTO.

- 
- When setting both the shutter speed and the iris/gain value, set the shutter speed and then set the iris/gain value.

### **Manual shutter speed adjustment**

- Avoid recording under fluorescent light, mercury light or sodium light because the color and brightness of the playback image may change.
- If you increase the shutter speed manually, the noise on the screen may increase.
- You may see vertical lines of light in the playback image of a brightly shining subject or highly reflective subject, but this is not a malfunction.
- During normal playback, image movement may not look smooth.
- When recording in an extremely bright place, the screen may change color or flicker. If so adjust the shutter speed manually to [1/60] or [1/100].

### **Manual iris/gain adjustment**

- If the gain value is increased, the noise on the screen increases.
- Depending on the zoom magnification, there are iris values that are not displayed.

# Playback

## Playback of motion pictures

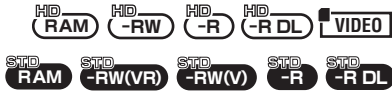

Play back the motion pictures recorded on the disc or SD card.

### ◇ HD mode

#### 1 Rotate the mode dial to select

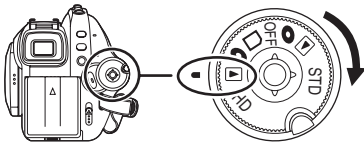

The lens cover closes.

#### 2 Press the cursor button up and then select the [O] or [D] tab.

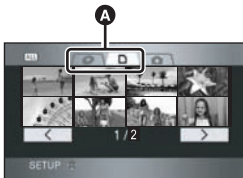

**A** Motion picture playback tab  
The motion pictures recorded on the disc or SD card are displayed as thumbnails.

#### 3 Select the scene to be played back.

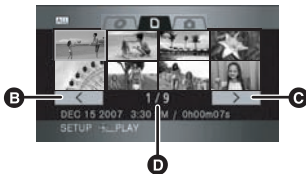

- B** Previous page
- C** Next page
- D** Scene number

The selected scene will be encircled by a yellow frame.

- If 9 or more scenes have been recorded, the next (or previous) page can be displayed by moving the cursor button left and right or moving the cursor button down, selecting [◀] / [▶] by moving the cursor button left and right and then pressing the center of the cursor button.
- The scene number display switches to the page number when the motion picture playback tab or [◀] / [▶] is selected.

#### 4 Press the cursor button.



The selected scene is played back on the full screen.

- The operation icon is automatically displayed on the screen.

#### 5 Move the cursor button to operate.

- ▶/||: Playback/Pause
- ◀◀: Rewind playback (→ 81)
- ▶▶: Fast forward playback (→ 81)
- : Stops the playback and shows the thumbnails.

## Repeat playback

Playback of the first scene starts after playback of the last scene finishes.

Press the **MENU** button, then select **[PLAY SETUP]** → **[REPEAT PLAY]** → **[ON]** and press the cursor button.

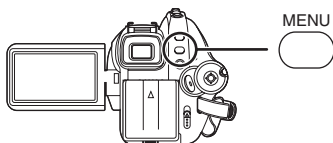

The [ ] indication appears on the thumbnail and full screen views.

- The following scenes can be played back repeatedly.
  - When [PLAY MODE] is set to [VIEW ALL]: All the scenes on the disc or SD card
  - When [PLAY MODE] is set to [BY DATE]: All the scenes on the selected date

### To cancel the repeat playback function

Press the **MENU** button, then select **[PLAY SETUP]** → **[REPEAT PLAY]** → **[OFF]** and press the cursor button.

### ◇ STD mode

#### 1 Rotate the mode dial to select

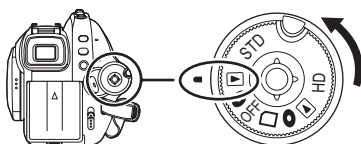

The lens cover closes.

- The motion pictures recorded on the disc are displayed as thumbnails.

#### 2 Select the scene to be played back.

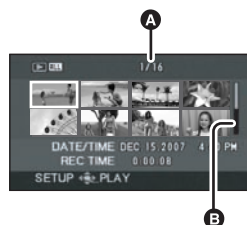

**A** Scene number

**B** Scroll bar display

The selected scene will be encircled by a yellow frame.

- When 9 or more scenes have been recorded, the next (or previous) page is displayed by moving the cursor button.
- If you move and hold the cursor button up or down, you can advance 8 scenes at a time. The screen will not change at this time, but the scene numbers and scroll bar display will change so release the cursor button when you have arrived at the page with the scene you want to display.

#### 3 Press the cursor button.



The selected scene is played back on the full screen.

- The operation icon is automatically displayed on the screen.

#### 4 Move the cursor button to operate.

- ▶/||: Playback/Pause
- ◀◀: Rewind playback (→ 81)
- ▶▶: Fast forward playback (→ 81)
- : Stops the playback and shows the thumbnails.

- Discs recorded in HD mode cannot be played back in STD mode and discs recorded in STD mode cannot be played back in HD mode.



- Sound will be heard only during normal playback.
- If pause play is continued for 5 minutes, the screen returns to the thumbnails.
- When the amount of time recorded on the scene is too short, playback may not be possible.
- Scenes which cannot be displayed as thumbnails (the thumbnails are displayed as [!]) cannot be played back. (HD mode) An error message appears and the screen shows the thumbnails.
- The power will not turn off when the LCD monitor and the viewfinder are closed and retracted.
- The date/time displayed may be different from the recording date/time and it may take time to display the thumbnail display when playing back motion pictures not recorded on this unit.
- (HD mode) The remaining time for playback indication will be reset to "0h00m00s" each scene.
- The high definition picture quality video signals that can be played back on this unit are 1920×1080/60i or 1440×1080/60i.
- (HD mode) This unit may degrade or not playback motion pictures recorded or created on other products, and other products may degrade or not playback motion pictures recorded on this unit, even if the products support AVCHD.
- (HD mode) If you continuously record motion picture data that exceeds 4 GB on an SD card and then play back the data on another device, the picture may momentarily stop where the data has reached 4 GB.
- If motion pictures recorded on another device with a 4:3 aspect ratio are played back on this unit in STD mode, the images on the LCD monitor and the viewfinder are squeezed vertically.

## Fast forward/rewind playback

**Move the cursor button right during playback.**  
**(Move the cursor button left to rewind.)**



Move the cursor button again to increase the speed. (The screen display changes from ►► to ►►►.)

- Normal playback is restored when you move the cursor button up.

## Operating with the remote control

Press the ◀◀ or ►► button during playback.

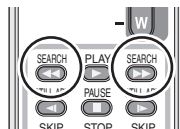

## Skip playback (to the start of a scene)

(Operation is possible with the remote control only.)

Press the ◀◀ or ►► button on the remote control during playback.

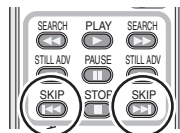

### Slow-motion playback

- 1 Move the cursor button up during playback to pause the playback.
- 2 Move and hold the cursor button right. (Slow-motion pictures will be played back in reverse when you move and hold the cursor button left.)



- Normal playback is restored when you move the cursor button up.
- When slow-motion pictures are played back in reverse, they will be shown continuously at approximately 1/1.5<sup>th</sup> the speed of normal playback in HD mode (intervals of 0.5 seconds) and at approximately 1/5<sup>th</sup> the speed of normal playback in STD mode.

### Operating with the remote control

Press the ◀ or ▶ button during playback.



### Frame-by-frame playback

The motion picture is advanced one frame at a time.

- 1 Move the cursor button up during playback to pause the playback.
- 2 Move the cursor button right. (The frames will be advanced one at a time in reverse when you move the cursor button left.)



- Normal playback is restored when you move the cursor button up.
- If the frames are advanced one at a time in reverse when in HD mode, they will be shown in intervals of 0.5 seconds.

### Operating with the remote control

- 1 Press the || button.

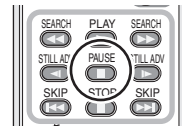

- 2 Press the ◀ or ▶ button.



### To adjust the speaker volume during playback

Adjust the speaker volume during playback.  
**Move the volume lever to change the volume level.**

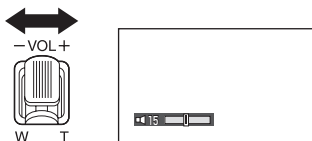

**Towards “+”:**  
 increases the volume  
**Towards “-”:**  
 decreases the volume

### Playing back motion pictures by date

Recorded scenes are grouped by date on this unit. Scenes recorded on the same day can be played back in succession.

- 1 Press the MENU button, then select [PLAY SETUP] → [PLAY MODE] → [BY DATE] and press the cursor button.

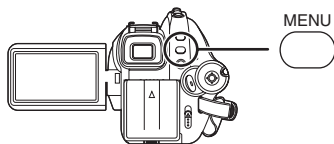

- 2 Select the playback date, then press the cursor button.



The scenes recorded on the date selected are displayed as thumbnails.

- 3 Select the scene to be played back.

### To return to playing back all the scenes

Press the MENU button, then select [PLAY SETUP] → [PLAY MODE] → [VIEW ALL] and press the cursor button.

- When [PLAY MODE] is set to [VIEW ALL], all recorded motion pictures will be played back in succession. ([ALL] is displayed.)

- Playing back all the scenes returns if the power is turned off or the mode dial is operated.
- Even if scenes are recorded on the same day, they are grouped separately in the following cases.

– When the number of scenes exceeds 99



– When the recording mode is changed from HN/HE to HG or HG to HN/HE (–1, –2... is added after the recording date displayed on the screen.)



– When the layers switch on a DVD-R DL



### Resuming the previous playback

If playback of a scene was stopped halfway, the playback can be resumed from where it was stopped.

**Press the MENU button, then select [PLAY SETUP] → [RESUME PLAY] → [ON] and press the cursor button.**

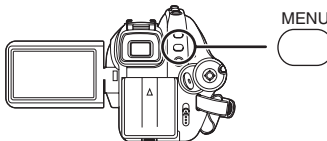

If playback of a motion picture is stopped, [ ] appears on the thumbnail view of the stopped scene.

### To cancel the resume playback function

Press the MENU button, then select [PLAY SETUP] → [RESUME PLAY] → [OFF] and press the cursor button.

- The memorized resume position is cleared if you turn off the power, operate the mode dial or eject the disc. (The [RESUME PLAY] setting is kept.)

## Still picture playback (JPEG images) on an SD card

PHOTO

### 1 Rotate the mode dial to select

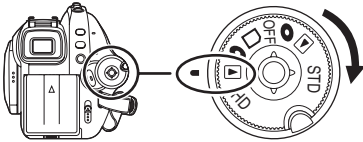

The lens cover closes.

### 2 Press the cursor button up and then right to select the [ ] tab.





**A** Still picture playback tab  
The still pictures recorded on the SD card are displayed as thumbnails (reduced-size images).

### 3 Select the file to be played back.





- B** Previous page
- C** Next page
- D** File number
- E** Folder/file name

The selected file will be encircled by a yellow frame.

- If 9 or more files have been recorded, the next (or previous) page can be displayed by moving the cursor button left and right or moving the cursor button down, selecting [  ] / [  ] by moving the cursor button left and

right and then pressing the center of the cursor button.

- The file number display switches to the page number when the still picture playback tab or [  ] / [  ] is selected.





### 4 Press the cursor button.



The selected file is played back on the full screen.

- The operation icon is automatically displayed on the screen.

### 5 Move the cursor button to operate.

- : Slide show (playback of the still pictures on the SD card in numerical order) start/pause.
- : Plays back the previous picture.
- : Plays back the next picture.
- : Stops the playback and shows the thumbnails.

### About still picture compatibility

- This unit is compliant with the unified standard DCF (Design rule for Camera File system) established by JEITA (Japan Electronics and Information Technology Industries Association).
- The file format supported by this unit is JPEG. (Not all JPEG formatted files will be played back.)
- If a non-standard file is played back, the folder/file name may not be displayed.
- This unit may degrade or not play back data recorded or created on another product and another product may degrade or not play back data recorded on this unit.
- While this unit accesses the SD card (the access lamp is lit), do not remove the SD card.
- Do not operate the mode dial during the slide show.

- It takes time to display the file, depends on the number of pixels of the file.
- Files which cannot be displayed as thumbnails (the thumbnails are displayed as [!]) cannot be played back.
- If you attempt to play back a file which is a different format or a damaged file, an error message appears and the screen shows the thumbnails.
- The date/time displayed may be different from the recording date/time and it may take time to display the thumbnail display when playing back still pictures not recorded on this unit.
- The power will not turn off when the LCD monitor and the viewfinder are closed and retracted.

# Editing

## Editing scenes

### Deleting scenes

This is for deleting scenes.



The deleted scenes cannot be restored.

- (HD mode) The remaining space on DVD-RW, DVD-R and DVD-R DL will not increase even if scenes are deleted.
- (STD mode) Scenes on DVD-RW (Video format), DVD-R and DVD-R DL cannot be deleted.

### Deleting scenes one at a time

HD mode

- ◇ Rotate the mode dial to select and then select the [ ] or [ ] tab.

STD mode

- ◇ Rotate the mode dial to select .

- 1 Press the button during playback.

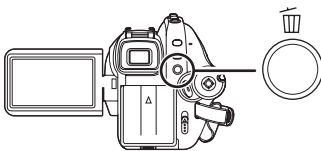

- 2 When the confirmation message appears, select [YES], then press the cursor button.

### Deleting multiple scenes from the thumbnail display

HD mode

- ◇ Rotate the mode dial to select and then select the [ ] or [ ] tab.

STD mode

- ◇ Rotate the mode dial to select .

- 1 Press the button while the thumbnail view screen is displayed.

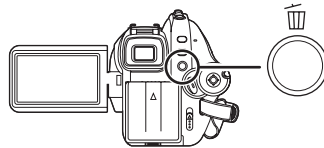

- 2 Move the cursor button up or down to select [ALL SCENES] (HD mode)/[ALL] (STD mode) or [SELECT] and press the cursor button.



- When [ALL SCENES] (HD mode)/[ALL] (STD mode) is selected, the following scenes except the protected scenes will be deleted. Proceed to step 5.
  - When [PLAY MODE] is set to [VIEW ALL]: All the scenes on the disc or SD card
  - When [PLAY MODE] is set to [BY DATE]: All the scenes selected by date

- 3 (Only when [SELECT] is selected in step 2) Select the scene to be deleted, then press the cursor button.



The selected scene is encircled by a red frame.

- When the cursor button is pressed again, the scene will be unselected.
- Up to 99 scenes (HD mode)/8 scenes (STD mode) can be selected in succession.

**4** (Only when [SELECT] is selected in step 2)  
Press the  button.

**5** When the confirmation message appears, select [YES], then press the cursor button.

(Only when [SELECT] is selected in step 2)

**To continue deleting other scenes**

Repeat steps 3-5.

**To complete editing**

Press the MENU button.



- You can also delete scenes by pressing the MENU button, selecting [EDIT SCENE] → [DELETE] and then selecting [ALL SCENES] (HD mode)/[ALL] (STD mode) or [SELECT].
- To delete an unwanted part of a scene, divide the scene first, and then delete the unnecessary part. (→ 87)
- Scenes which cannot be played back (the thumbnails are displayed as [  ]) cannot be deleted.
- Protected scenes cannot be deleted.
- Do not open the card slot cover while deleting. The deletion will stop.
- In case of [ALL SCENES] (HD mode)/[ALL] (STD mode), the deletion may take time if there are many scenes on the disc or SD card.
- Do not turn off this unit while deleting.
- When you delete scenes, use a battery with sufficient battery power or use the AC adaptor.
- If you delete scenes recorded on other products with this unit, all the data related to the scenes may be deleted.
- It may not be possible to delete scenes that have been divided to approximately 1 second or less in STD mode.

**Dividing a scene to delete**  
This is for dividing a scene into two to delete an unnecessary portion.



To delete an unnecessary portion of a scene, first divide the scene and then delete the unnecessary portion.

**HD mode**

- ◇ Rotate the mode dial to select  and then select the [  ] or [  ] tab.

**STD mode**

- ◇ Rotate the mode dial to select  .

- 1** Press the MENU button, then select [EDIT SCENE] → [DIVIDE] → [SET] (HD mode) or [YES] (STD mode) and press the cursor button.

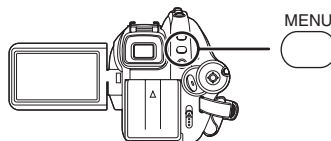

- 2** Select the scene to be divided, then press the cursor button.

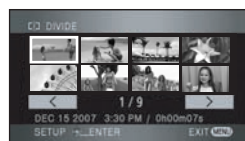

The selected scene is played back.

- 3** When you reach the area where you want to divide the scene, press the cursor button down to set the dividing point.



- Using slow-motion playback or frame-by-frame playback makes it easy to search for the point where you want to divide the scene. (→ 82)

### 4 When the confirmation message appears, select [YES], then press the cursor button.

### 5 Delete the unnecessary scenes.

- Refer to P86 for deleting scenes.

#### *To continue dividing other scenes*

Repeat steps 2-4.

#### *To complete editing*

Press the MENU button.

#### *(HD mode only)*

#### *To delete all the divided points*

Press the MENU button, then select [EDIT SCENE] → [DIVIDE] → [CANCEL ALL] and press the cursor button.

- When the confirmation message appears, select [YES], then press the cursor button.
  - All divided points set on this unit will be canceled.
  - The scenes that were deleted after division cannot be recovered.
- 
- Scenes cannot be divided if the number of scenes has reached 999.
  - When the amount of time recorded on the scene is too short, dividing may not be possible.
  - If images that have been divided are played back on another device, the points where the scenes join may not be clear.
  - Data that has been recorded on another device cannot be divided.
  - When [CANCEL ALL] is selected, the divided points of all scenes are deleted and the unit turns back to the setting that plays back all scenes even if you selected to play back the scenes by date.
  - Data that has been recorded or edited on another device cannot be divided and the divided points cannot be deleted.
  - Discs other than DVD-RAM cannot be divided or deleted and the divided points cannot be deleted when the remaining space on the disc becomes small.

## Protecting scenes

This is for preventing scenes from being deleted by mistake.



Recorded scenes can be protected so that they are not deleted by mistake.

**(Even if you protect some scenes, formatting the disc or SD card will delete them.)**

- ◇ Rotate the mode dial to select and then select the [ ] or [ ] tab.

- 1 Press the MENU button, then select [PLAY SETUP] → [SCENE PROTECT] → [YES] and press the cursor button.
- 2 Select the scene to be protected and then press the cursor button.



The [ ] indication appears and the scene is protected.

- Press the cursor button again to cancel the setting.
- 2 or more scenes can be set in succession.

#### *To complete the settings*

Press the MENU button.



## Copying from an SD card to a disc

### VIDEO

You can easily copy motion pictures recorded on an SD card with this unit to a disc.

- Compatible discs are DVD-RAM, DVD-RW, DVD-R and DVD-R DL.

### Copying all the scenes at one time

- ◇ Connect the AC adaptor to this unit, then insert a DVD-RAM or a DVD-RW formatted on this unit (→ 93) or a new disc.

- ◇ Rotate the mode dial to select  and then select the [D] tab.

- 1 Press the DISC COPY button while the thumbnail view screen is displayed.

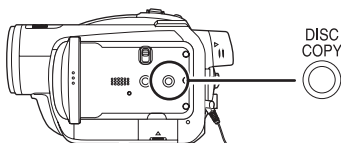

- 2 Move the cursor button up or down to select [YES] and press the cursor button.



- The number of discs necessary for copying by disc type.
  - When 2 or more discs are necessary for copying, follow the on-screen instructions to switch discs.
  - When copying is complete, press the MENU button to exit the message screen.

### Selecting the scenes to copy

- ◇ Connect the AC adaptor to this unit, then insert a DVD-RAM or a DVD-RW formatted on this unit (→ 93) or a new disc.

- ◇ Rotate the mode dial to select  and then select the [D] tab.

- 1 Press the MENU button, then select [DISC COPY] → [COPY SELECT] → [YES] and press the cursor button.

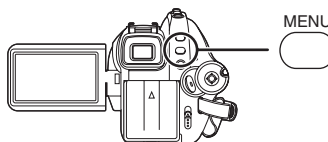

- 2 Select the scene to be copied and then press the cursor button.

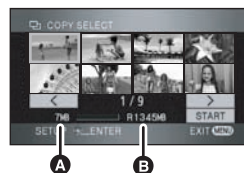

- Scene size

- Remaining space on the disc

The selected scene is encircled by a red frame.

- When the cursor button is pressed again, the selected scene will be canceled.
- Up to 99 scenes can be set in succession.
- If you select a scene with a scene size that exceeds the remaining space on the disc, the remaining space on the disc display will turn red and the amount exceeded will be displayed.

Cancel the selected scene and select scenes that do not exceed the space on 1 disc.

- 3 Move the cursor button up or down to select [START] and press the cursor button.

#### 4 When the confirmation message appears, select [YES], then press the cursor button.

##### To complete copying

Press the MENU button.

- Do not turn off the power on this unit while copying.
- You can copy all the scenes at one time when [COPY ALL] is selected in step 1.
- We recommend preparing a spare disc before copying.
- The order in which the scenes were copied cannot be changed.
- Data that has been recorded on another device cannot be copied.
- When 2 or more discs are necessary for copying, the last scene copied to a disc is automatically divided to fit the space on the disc.
- If you will delete all the data on the SD card when copying is complete, be sure to play back the discs to check that they have been copied correctly before deleting.

## Editing still pictures



### Deleting still pictures

This is for deleting still picture files recorded on SD cards.

PHOTO

The deleted files cannot be restored.

### Deleting files one at a time

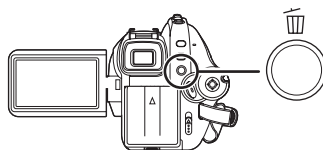

- ◇ Rotate the mode dial to select and then select the [  ] tab. 

- 1 Press the  button during playback.



- 2 When the confirmation message appears, select [YES], then press the cursor button.

### Deleting multiple files from the thumbnail display

- ◇ Rotate the mode dial to select and then select the [  ] tab. 

- 1 Press the  button while the thumbnail view screen is displayed.

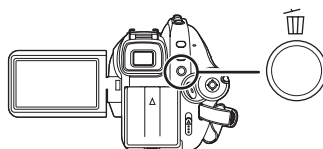

## 2 Move the cursor button up or down to select [ALL SCENES] or [SELECT] and press the cursor button.

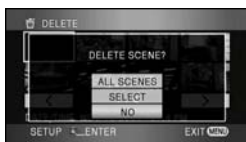

- When [ALL SCENES] is selected, all files on the SD card except the protected files will be erased. Proceed to step 5.

## 3 (Only when [SELECT] is selected in step 2) Select the file to be deleted, then press the cursor button.



The selected file is encircled by a red frame.

- When the cursor button is pressed again, the file will be unselected.
- Up to 99 files can be selected in succession.

## 4 (Only when [SELECT] is selected in step 2) Press the button.

## 5 When the confirmation message appears, select [YES], then press the cursor button.

(Only when [SELECT] is selected in step 2)

### To continue deleting other files

Repeat steps 3-5.

### To complete editing

Press the MENU button.

## Deleting still picture files recorded on an SD card by other products

A still picture file (other than JPEG) that cannot be played back on this unit may be erased.

- Protected files cannot be deleted.



- Do not open the card slot cover while deleting. The deletion will stop.
- In case of [ALL SCENES], the deletion may take time if there are many files on the SD card.
- Do not turn off this unit while deleting.
- When you delete files, use a battery with sufficient battery power or use the AC adaptor.
- If files conforming to DCF standard are deleted, all the data related to the files will be deleted.

## Protecting still pictures

This is for preventing still picture files from being deleted by mistake.

### PHOTO

Files recorded on an SD card can be protected so that they are not deleted by mistake. (Even if you protect some files on an SD card, formatting the SD card will delete them.)

- ◇ Rotate the mode dial to select  and then select the [] tab.

## 1 Press the MENU button, then select [PLAY SETUP] → [SCENE PROTECT] → [YES] and press the cursor button.

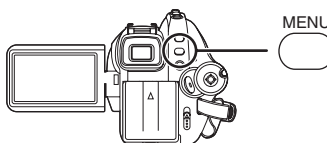

## 2 Select the file to be protected and then press the cursor button.

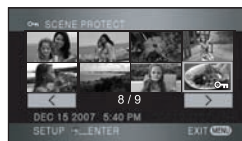

The [] indication appears and the file is protected.

- Press the cursor button again to cancel the setting.
- 2 or more files can be set in succession.

### To complete the settings

Press the MENU button.

## DPOF setting



This is for writing the printing data on an SD card.

### PHOTO

You can write the data of the still pictures to be printed and the number of prints (DPOF data) onto the SD card.

### What is DPOF?

DPOF (Digital Print Order Format) is a format which allows the user of a digital camera to define which captured images on the SD card are to be printed, together with information on the number of copies they wish to print. (Please note: Not all commercial printing services support this feature at his time.)

◇ Rotate the mode dial to select  and then select the  tab.

- 1 Press the MENU button, then select [PLAY SETUP] → [DPOF SET] → [SET] and press the cursor button.

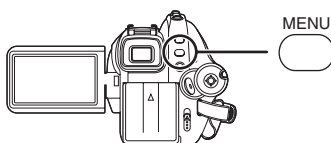

- 2 Select the file to be set and then press the cursor button.



The number of prints set to be in DPOF is displayed.

- 3 Move the cursor button up or down to select the number of prints, then press the cursor button.

- To cancel the setting, set the number of prints to [0].

- You can also select multiple files in succession.

### To complete the settings

Press the MENU button.

### To cancel all DPOF settings

Press the MENU button, then select [PLAY SETUP] → [DPOF SET] → [CANCEL ALL] and press the cursor button.

- When the confirmation message appears, select [YES], then press the cursor button.
- 
- The DPOF setting can be established for up to 999 prints.
  - DPOF setting made on other devices may not be recognized by this unit. Please perform the DPOF settings on this unit.
  - You cannot add the recording date to pictures to be printed with the DPOF settings.

# Disc and card management

## Formatting

### Formatting discs

This is for initializing discs.



Please be aware that if a disc is formatted, then all the data recorded on the disc will be erased. Store important data on a computer, etc.

#### HD mode

- ◇ Rotate the mode dial to select or and then select the [] tab.

#### STD mode

- ◇ Rotate the mode dial to select or .

- 1 Press the MENU button, then select [DISC SETUP] or [SETUP] → [FORMAT DISC] → [YES] and press the cursor button.

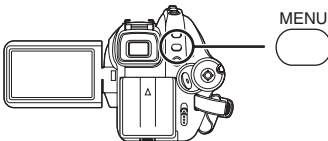

- 2 (When formatting a DVD-RW in STD mode only)  
Select format type, then press the cursor button.



- 3 When the confirmation message appears, select [YES], then press the cursor button.

- When formatting is complete, press the MENU button to exit the message screen.
- Use this unit to format discs. If a disc is formatted on other products (such as a computer), the time spent for recording may become longer and you may not be able to use the disc.
- When using a double sided disc, format each side.
- It may not be possible to format a disc with many scratches or dirt. Such discs cannot be used.
- Do not turn this unit off, while formatting.
- When you format the disc, use a battery with sufficient battery power or the AC adaptor.
- Refer to P27 for information about formatting discs recorded on another device or in another mode.

## Formatting SD cards

This is for initializing SD cards.



Please be aware that if an SD card is formatted, then all the data recorded on the card will be erased. Store important data on a computer, etc.

◇ Rotate the mode dial to select or .

**1** Press the MENU button, then select [SETUP] → [FORMAT CARD] → [YES] and press the cursor button.

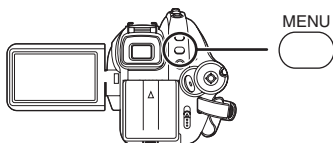

**2** When the confirmation message appears, select [YES], then press the cursor button.

- When formatting is complete, press the MENU button to exit the message screen.
- Use this unit to format SD cards. If an SD card is formatted on other products (such as a computer), the time spent for recording may become longer and you may not be able to use the SD card.
- Depending on the type of SD card being used, it may take time to format.
- Do not turn this unit off, while formatting.
- When you format the SD card, use a battery with sufficient battery power or the AC adaptor.
- Do not open the card slot cover while formatting.

## Finalizing a disc

### Finalizing a disc



If you insert a DVD-RW, DVD-R or DVD-R DL disc recorded in this unit (that has not been finalized) into another device such as DVD recorder, computer, etc., the disc may become unusable.

Be sure to finalize the disc on this unit before inserting it in other devices.

To allow the disc to be played back on other devices that support AVCHD (HD mode)

### Important Notice

Do not insert discs which have been recorded in AVCHD format into devices which do not support the AVCHD format. In some cases the disc may get stuck in the device. The disc will not play back on devices that do not support the AVCHD format.

### DVD-RW, DVD-R and DVD-R DL:

- After finalizing, the disc becomes play-only and you can no longer record.
- When you un-finalize a DVD-RW, the disc can be used for recording again. (→ 96)

### DVD-RAM:

- It is not necessary to finalize DVD-RAM.

To allow the disc to be played back on other DVD players etc. (STD mode)

#### DVD-RAM:

- It is not necessary to finalize DVD-RAM.



#### DVD-RW (VR format):

- DVD-RW (VR format) after finalization can be recorded and edited in the same way as DVD-RW (VR format) before finalization.
- After finalizing a DVD-RW (VR format) once, you cannot finalize it again. (Even if you record on or edit a DVD-RW (VR format) after finalizing, it is not necessary to finalize it again.)

#### DVD-RW (Video format), DVD-R and DVD-R DL:

- After finalizing, the disc becomes play-only and you can no longer record.
- When you un-finalize a DVD-RW (Video format), the disc can be used for recording again. (→ 96)

#### HD mode

- ◇ Rotate the mode dial to select  and then select the [  ] tab.

#### STD mode

- ◇ Rotate the mode dial to select  .

### 1 Connect this unit to the AC adaptor.

- Finalization cannot be executed when using a battery.
- If the power supply stops while finalizing, the finalization will fail and the data may be damaged.

- 2 Press the MENU button, then select [DISC SETUP] → [FINALIZE] → [YES] and press the cursor button.

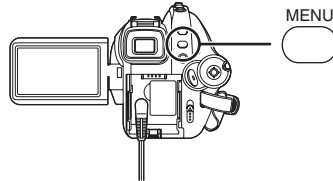

- 3 When the confirmation message appears, select [YES], then press the cursor button.

- When finalizing is complete, press the MENU button to exit the message screen.

#### HD mode

- When finalizing a DVD-RW, DVD-R or DVD-R DL a top menu containing thumbnails is created.

#### STD mode

- When finalizing a DVD-RW (Video format) or DVD-R, a top menu containing thumbnails is created.



- 
- Do not finalize a disc recorded on this unit using any other device.
  - When using a double sided disc, finalize each side.
  - The top menu created when finalizing does not appear on this unit. It appears when the disc is played back on other devices.
  - Depending on the condition of the disc, the time it takes for finalizing will differ. It may take up to 22 minutes.
  - Do not allow the unit to be heavily vibrated or shaken while finalizing a disc. Doing so may prevent the disc from being finalized resulting in an unplayable disc.
  - If the power supply stops while finalizing, the finalization will fail and the disc may become unplayable on other devices even if disc repair is carried out.

## Un-finalizing a DVD-RW

This is for un-finalizing a DVD-RW so that it can be used for recording.



### HD mode

- ◆ Rotate the mode dial to select  and then select the [  ] tab.

### STD mode

- ◆ Rotate the mode dial to select  .

- 1 Press the MENU button, then select [DISC SETUP] → [UN-FINALIZE] → [YES] and press the cursor button.

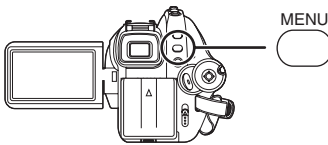



- 2 When the confirmation message appears, select [YES], then press the cursor button.

- When un-finalizing is complete, press the MENU button to exit the message screen.
- 
- (HD mode) Discs other than DVD-RW cannot be un-finalized. If there is no space remaining on the DVD-RW, the disc may not be un-finalized.
  - (STD mode) Discs other than DVD-RW (Video format) cannot be un-finalized. DVD-RW (VR format) after finalization can be recorded and edited in the same way as DVD-RW (VR format) before finalization.
  - When you un-finalize the disc, use a battery with sufficient battery power or the AC adaptor.

## Creating a top menu

A top menu is displayed when a DVD-RAM is played back on other devices that support AVCHD.



- ◆ Rotate the mode dial to select  and then select the [  ] tab.

- 1 Connect this unit to the AC adaptor.

- Creating a top menu cannot be executed when using a battery.
- If the power supply stops while creating a top menu, the data may be damaged.

- 2 Press the MENU button, then select [DISC SETUP] → [CREATE TOP MENU] → [YES] and press the cursor button.

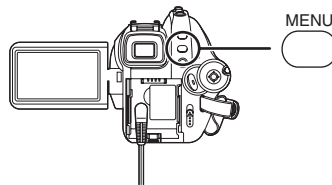

- 3 When the confirmation message appears, select [YES], then press the cursor button.

- After creating the top menu, press the MENU button to exit the message screen.
- 
- If a top menu is created, the disc becomes play-only and you can no longer record.
  - The top menu is not displayed on the unit, but it will be displayed when the disc is played back on other devices that support AVCHD.
  - Except for DVD-RAM, the top menu is created during finalizing.

## Deleting the top menu

If you insert a DVD-RAM on which a top menu was created, the confirmation message appears when you set a recording mode. If you select [YES] to erase the top menu, the DVD-RAM can be recorded and edited in the same way as before the top menu was created.











## Protecting a disc

This is for protecting discs (write protection) when they are being ejected from this unit to prevent them from being formatted if they are inserted in other devices.

Discs protected using this unit cannot be edited or used to record on other devices, but they can be used in the same way as unprotected discs with this unit.

### Auto Protect Operation

	Insert into unit →	Operations on the unit →	Status of ejected disc
 Protected disc	When auto protect is [ON]	Motion picture recording, editing, etc.	 Protected
		Playback only	
 Unprotected disc		Motion picture recording, editing, etc.	Unprotected
		Playback only	
 Protected disc	When auto protect is [OFF]	Motion picture recording, editing, etc.	Unprotected
		Playback only	 Protected
 Unprotected disc		Motion picture recording, editing, etc.	Unprotected
		Playback only	

- After disc writing operations (recording motion pictures, editing, finalizing, un-finalizing, creating a top menu and deleting a top menu), the disc is protected when [AUTO PROTECT] is [ON], and it is not protected when [AUTO PROTECT] is [OFF].
- When the protected disc is ejected, "WRITE PROTECTED DISC-CANNOT BE RECORDED BY OTHER DEVICES." appears on the screen.

- ◆ Rotate the mode dial to select  or  and then select the [] tab.

Press the MENU button, then select [DISC SETUP] or [SETUP] → [AUTO PROTECT] → [ON] and press the cursor button.

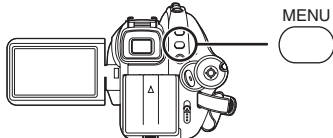

- This function's default setting is [ON].
- We recommend that the auto protect function is set to [ON] in order to prevent accidental deletion on other devices. If discs recorded on this unit are inserted into other devices without protecting them, a message may be displayed prompting you to format the disc. If the disc is formatted, the data on it will be erased, and the process cannot be reversed.

- If a disc with no recorded motion pictures is ejected, it will not be protected.

### ■ To release the disc protection

Erase all the motion pictures on the disc or format the disc.

- Please be aware that if a disc is formatted, then all the data recorded will be erased and cannot be recovered.
- The disc will need to be re-formatted on the device you will use.

## Disc protection setting



This is for preventing recorded contents from being deleted or edited by mistake. Further recording and editing is not possible on protected discs until the protection is released.

- ◆ Rotate the mode dial to select  .

- 1 Press the MENU button, then select [DISC SETUP] → [DISC PROTECT] and press the cursor button.

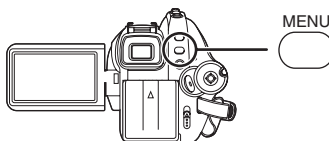

- 2 When the confirmation message appears, select [YES], then press the cursor button.

### To release disc protection

- 1) Press the MENU button, then select [DISC SETUP] → [DISC PROTECT] and press the cursor button.
- 2) When the confirmation message appears, select [YES], then press the cursor button.

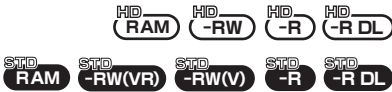

- If the disc has been protected on another device, it may not be possible to release the protection on this unit. In this case, release the protection on the device that you used to protect it.

## Displaying disc information



Information such as the type of recorded disc, the number of recorded scenes, the remaining space, whether or not the disc is finalized etc. is displayed.

### HD mode

- ◇ Rotate the mode dial to select  and then select the [  ] tab.

### STD mode

- ◇ Rotate the mode dial to select  or  .

Press the MENU button, then select [DISC SETUP] → [INFORMATION] → [YES] and press the cursor button.

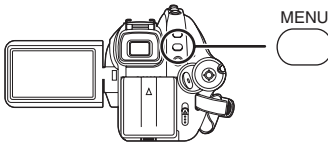

### To exit the information screen

Press the MENU button.

## With other products

### Watching Video/Pictures on your TV

#### Playback on TV

The motion pictures and still pictures recorded on this unit can be played back on a TV screen.

Connect this unit to a TV with one of the following terminals. An HDMI cable (optional) is required when connecting to an HDMI terminal of the TV.

- ◇ Difference in picture quality depending on the terminal used for connection

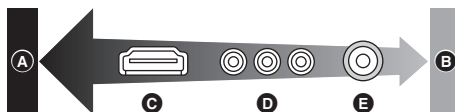

- A** High quality
- B** Standard quality
- C** HDMI terminal
- D** Component terminal
- E** Video terminal

- Connect with the AV cable for pictures recorded in conventional standard picture quality. The pictures cannot be played back in high definition picture quality.

TV you use	Reference items
TV with a HDMI terminal	① Connecting with a HDMI cable (optional) (→ 101)
TV with a component terminal	② Connecting with the component cable (supplied) and the AV cable (supplied) (→ 105)
Other TVs	③ Connecting with the AV cable (supplied) (→ 106)

- Do not use any other AV cables except the supplied one.
- Do not use any other component cables except the supplied one.
- Use the AC adaptor to free you from worrying about the battery running down.

#### ■ To display the on-screen information on the TV

The information displayed on the screen (operation icon, time code etc.) can be displayed on the TV.

Press the EXT DISPLAY button on the remote control.

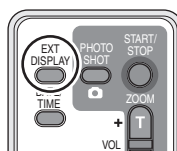

- Press the button again to erase the information.
- The screen on this unit will not change.

**When using the following Panasonic TVs, you can directly insert an SD card into the SD card slot on the TV and then play it back.**

- TH-50PZ750U
- TH-58PZ750U

- For details on how to play back, please read the operating instructions for the TV.

## 1 Connecting with a HDMI cable (optional)



### What is HDMI?

HDMI is the next-generation interface for digital devices. When this unit is connected to a HDMI compatible device, the image and audio can be output with a digital signal. If you connect this unit and a HDMI compatible high definition TV and then play back the recorded high definition images (→ 14), you can enjoy them in high resolution with high quality sound.

**If you connect this unit to a Panasonic TV compatible with EZ Sync, linked operations are possible. (→ 103)**

- Use the AC adaptor to free you from worrying about the battery running down.

### 1 Connect this unit and a TV with the HDMI cable (optional).

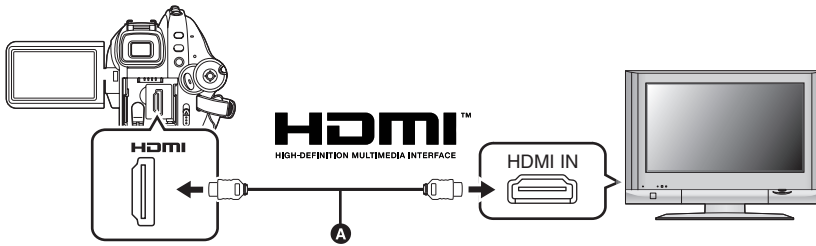

- Use a HDMI cable (optional) **A** with the logo shown on above.

### 2 Set the mode dial to to turn on the power.

### 3 Select the video input on the TV that this unit is connected to.

Example:

Select the [HDMI] channel etc.

(The name of the channel may differ depending on the connected TV.)

### 4 Start playback on this unit.

The image and audio are output on the TV.

### ■ If the image or audio from this unit does not appear on the TV

- Check the connections.
- Check that the plugs are inserted as far as they go.
- Check the input setting (input switch) and the audio input setting on the TV.  
(For more information, please read the operating instructions for the TV.)
- Check [HDMI RESOLUTION]. (→ 102)

## ■ About the settings when connecting with HDMI

When this unit is connected to another device with a HDMI cable, the output setting on this unit can be changed.

### HDMI output resolution

You can switch the method to output the images.

**Press the MENU button, then select [SETUP] → [HDMI RESOLUTION] desired item and press the cursor button.**

[AUTO]: The output resolution is automatically set based on the information from the connected TV.

Information from the connected TV	Output resolution
720p, 1080i	1080i
Others	480p

[1080i]: The interlace method with 1080 available scan lines is used for output.

[480p]: The progressive method with 480 available scan lines is used for output.

- If the images are not output on the TV when the setting is [AUTO], switch to the method – [1080i] or [480p] – which enables the images to be displayed on your TV. (Please read the operating instructions for the TV.)
- Be sure to connect to an HDMI input terminal. Do not connect to an HDMI output terminal on other products.

### 1080i

This is an interlace scan method which scans 1080 scan lines to display a high definition image. The 1080 available scan lines are divided in half and scanned on the screen alternatively every 1/60<sup>th</sup> of a second. The number of available scan lines is more than double the 480 scan lines used to display standard images until now so the images have clearer detail and a lot of presence.

### 480p

This is a progressive scan method which scans all 480 available scan lines on the screen at the same time every 1/60<sup>th</sup> of a second. This method reduces the flickering as the scan lines are not scanned on the screen alternatively like in the interlace method.

### 480i

This is an interlace scan method in which the 480 available scan lines are divided in half and scanned on the screen alternatively every 1/60<sup>th</sup> of a second.

### Interlace method/progressive method

Video signals until now (NTSC) are referred to as 480i (“i” is short for interlace) whereas a high-density video signal that doubles the number of scan lines is called 480p (“p” is short for progressive).

The component terminal and the HDMI terminal on this unit are also compatible with high definition image output [1080i]. It is necessary to have a compatible TV to enjoy progressive and high definition images.

## Playback using EZ Sync™ (HDAVI Control™)



If you connect this unit to a Panasonic TV compatible with EZ Sync™ (HDAVI Control™) with a HDMI cable, the following linked operations become possible.

- You can use the remote control for the TV to control playback on this unit.
- If you use the remote control for the TV to turn off the power, the power on this unit also turns off. (The power cannot be cut off when recording a motion picture, formatting a disc, finalizing a disc, un-finalizing a disc, deleting data, recovering data or connecting the unit to a computer with a USB cable.)
- If you connect with a HDMI cable and then turn on the power, the input channel on the TV automatically switches to this unit's screen. If the TV's power is in standby status, it will turn on automatically (if [Set] has been selected for the TV's [Power on link] setting).
  - Depending on the HDMI terminal on the TV, the input channel may not switch automatically. In this case, use the remote control for the TV to switch the input channel. (For details on how to switch input, please read the operating instructions for the TV.)
- If EZ Sync does not work properly, refer to page 145.

### 1 Connect this unit to a Panasonic TV compatible with EZ Sync with a HDMI cable (optional).

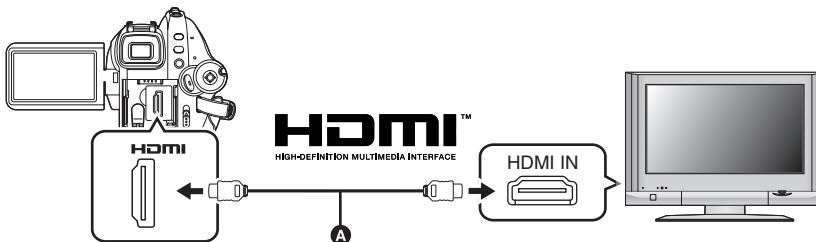

- Use a HDMI cable (optional) **A** with the logo shown on above.
- If the TV has two or more HDMI input terminals, it is recommended to connect this unit to HDMI2 or HDMI3.

### 2 EZ Sync must be activated on the connected TV.

- Read the operating instructions of the TV for how to set etc.

### 3 Set the mode dial to to turn on the power.

### 4 Press the MENU button, then select [SETUP] → [EZ Sync] → [ON] and press the cursor button.

- The default setting is [ON].

## 5 Operate with the remote control for the TV.

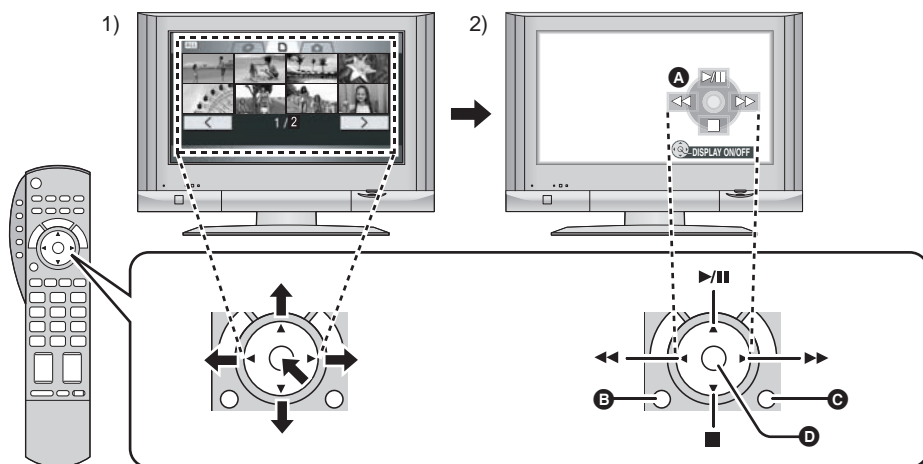

1) Press the button up, down, left or right to select a scene or file to be played back, and then press the button in the center to set it.

2) Activate the operation icons that are displayed on TV screen with the remote control for the TV.

**A** Operation icons

**B** Display operation icons

**C** Cancel operation icons

**D** Display/cancel operation icons

• The playback operation is performed the same as on this unit.

– Playing back motion pictures (→ 79)

– Playing back still pictures (→ 84)

### To cancel EZ Sync™ (HDAVI Control™)

Press the MENU button, then select [SETUP] → [EZ Sync] → [OFF] and press the cursor button.

- If you are unsure whether or not the TV you are using are compatible with EZ Sync, read the operating instructions for the TV.
- Available linked operations between this unit and a Panasonic TV is different depending on the types of Panasonic TVs even if they are compatible with EZ Sync. Refer to the operating instructions of the TV for the operations that support on the TV.
- Operation is not possible with a cable that is not based on the HDMI standard.

We recommend using Panasonic cables.

Part numbers: RP-CDHG15 (1.5 m/4.9 feet), RP-CDHG30 (3.0 m/9.8 feet), RP-CDHG50 (5.0 m/16.4 feet) etc.



## 2 Connecting with the component cable (supplied) and the AV cable (supplied)



- Use the AC adaptor to free you from worrying about the battery running down.

### 1 Connect this unit to a TV with the component cable (supplied) and the AV cable (supplied).

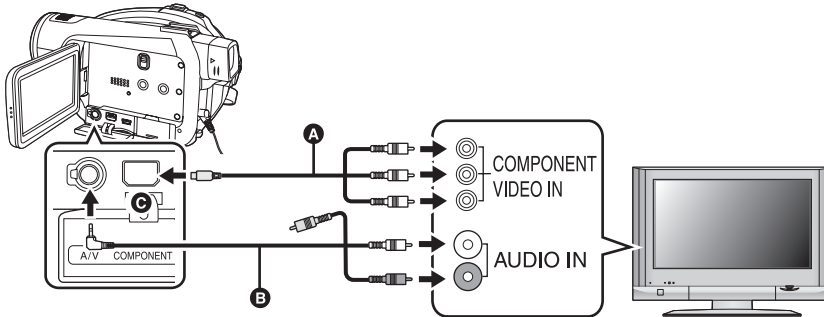

**A** Component cable (supplied)

**B** AV cable (supplied)

- Connect to terminals of the same color.
- The component terminal **C** is for outputting images only so be sure to also connect the AV cable. (Insert it in the audio input terminal for the component terminal input. Refer to the operating instructions of the TV for details.)

### 2 Set the mode dial to to turn on the power.

### 3 Select the video input on the TV that this unit is connected to.

Example:

Select the [Component] channel etc.

(The name of the channel may differ depending on the connected TV.)

### 4 Start playback on this unit.

The image and audio are output on the TV.

## ■ About the setting when connecting the component terminals

When this unit is connected to a TV with the component cable, the output setting on this unit can be changed. Set it to match the terminal on the TV that you connect to.

**Press the MENU button, then select [SETUP] → [COMPONENT OUT] desired item and press the cursor button.**

[480i]: When connecting to the component terminal on the TV compatible with 480i.  
(Playback is in standard quality.)

[1080i]: When connecting to the component terminal on the TV compatible with 1080i.  
(Playback is in high definition quality.)

**■ If the image or audio from this unit does not appear on the TV**

- Check the connections.
  - Check that the plugs are inserted as far as they go.
  - **Check the TV's input setting (input switch).** (For more information, please read the operating instructions for the TV.)
- 
- If the images are not displayed correctly on a wide-screen TV, adjust the setting in screen mode on the TV. (For more information, please read the operating instructions of the TV.) If the pictures are displayed squeezed horizontally on a regular TV (4:3), change the setting on this unit. (→ 107)

**3 Connecting with the AV cable (supplied)**



- Use the AC adaptor to free you from worrying about the battery running down.

**1 Connect this unit to a TV with the AV cable (supplied).**

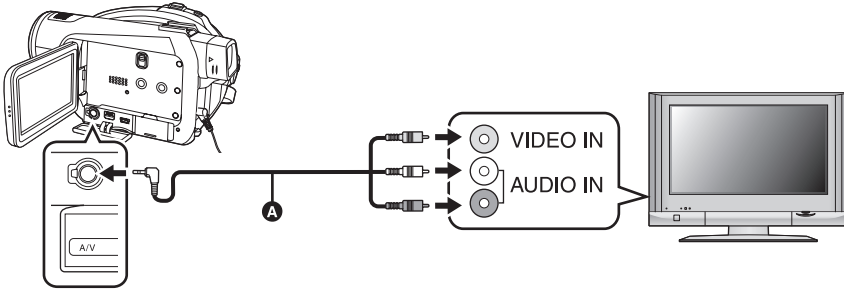

**A** AV cable (supplied)

**2 Set the mode dial to  to turn on the power.**

**3 Select the video input on the TV that this unit is connected to.**

Example:

Select the [Video 2] channel etc.

(The name of the channel may differ depending on the cable.)

**4 Start playback on this unit.**



The image and audio are output on the TV.

## ■ To watch images with a 16:9 aspect ratio on a regular TV (4:3)

When playing back motion pictures or still pictures recorded on this unit with a 16:9 aspect ratio on a TV with a 4:3 aspect ratio, the images on the screen may be squeezed horizontally. In this case, change the menu setting to play back the pictures in the original aspect ratio. (Depending on the TV setting, the pictures may not be displayed correctly. For more information, please read the operating instructions of your TV.)

**Press the MENU button, then select [SETUP] → [TV ASPECT] → [4:3] and press the cursor button.**

Example of images with a 16:9 aspect ratio on a regular TV (4:3)

[TV ASPECT] setting	
[16:9]	[4:3]
	

## ■ If the image or audio from this unit does not appear on the TV

- Check the connections.
  - Check that the plugs are inserted as far as they go.
  - **Check the TV's input setting (input switch).** (For more information, please read the operating instructions for the TV.)
- 
- (HD mode) When a HDMI cable is connected at the same time, priority is given to the output from the HDMI cable.
  - (HD mode) When the component cable is connected at the same time, priority is given to the component cable for image output.
  - If the images are not displayed correctly on a wide-screen TV, adjust the setting in screen mode on the TV. (For more information, please read the operating instructions of the TV.)

## With Blu-ray Disc Player, DVD recorder, DVD player, computer etc.

Do not insert DVD-RW, DVD-R or DVD-R DL discs that have not been finalized into a Blu-ray Disc Player, DVD recorder, DVD player, computer etc. Doing so could result in an unusable disc. Also, when inserting discs into a Blu-ray Disc Player, DVD recorder, DVD player, computer etc, a message may be displayed prompting you to format the disc, but doing so will delete important data which cannot be restored, so do not format the disc.

### Playback using Blu-ray Disc Players

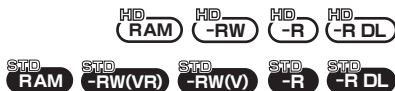

Discs recorded with this unit can be played back on Panasonic Blu-ray Disc Players/Recorders.

#### Devices which can play back discs recorded with this unit

– DMP-BD10 Blu-ray Disc Player

- 1 (Only when playing back DVD-RW, DVD-R or DVD-R DL discs)  
**Finalize the disc using this unit.**  
(→ 94)
- 2 **Insert the disc into a Blu-ray Disc Player to play it back.**

- Refer to the Blu-ray Disc Player operating instructions for details on how to play back discs.

### Playback on DVD recorder, DVD player, computer etc.



- When playing back a disc on a DVD recorder/player, place the device so that the disc lies flat.

#### ■ **Playing back a DVD-RAM or a DVD-RW (VR format)**

- 1 [Only when playing back DVD-RW (VR format) discs]

**Finalize the disc on this unit.**  
(→ 94)

#### 2 **Insert the disc in the playback device and then play it back.**

- Playback is only possible on devices that support 8 cm (3") DVD-RAM or DVD-RW (VR format). Refer to the operating instructions of the playback device.
- You cannot record images that allow "One time only recording" on a 8 cm (3") disc.

#### ■ **Playing back a DVD-RW (Video format) or a DVD-R**

- 1 **Finalize the disc on this unit.**  
(→ 94)

#### 2 **Insert the disc in the playback device and then play it back.**

- Playback is possible on devices that support 8 cm (3") DVD-Video, but playback on all DVD players is not guaranteed.
- Playback of DVD-R DL is only possible on devices that support 8 cm (3") DVD-R DL. Refer to the operating instructions of the playback device.
- The recording time is not displayed.

## With a DVD recorder or video device

### Dubbing images onto other video device

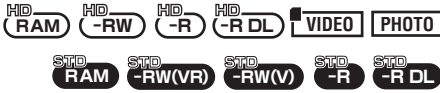

- Images are dubbed in standard picture quality.
- Use the AC adaptor to free you from worrying about the battery running down.

#### 1 Connect this unit and a video device.

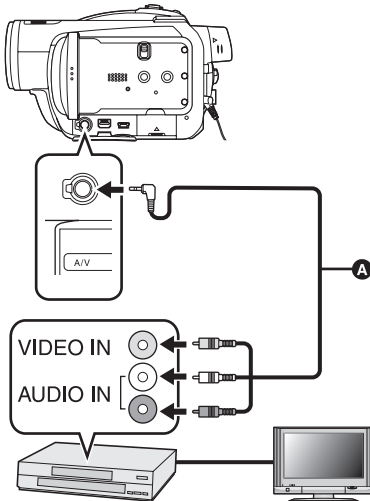

- A** AV cable (supplied)
- Insert the plugs as far as they will go.

#### 2 Set the mode dial to to turn on the power.

#### 3 Change the video input on the video device and TV that this unit is connected to.

- The channel set will differ depending on the terminal to which the unit is connected.

#### 4 Start playback on this unit.

#### 5 Then start recording on the connected device.

- See the operating instructions of the video device for details.

#### To stop dubbing

- 1) Stop recording on the connected device.
- 2) Then stop playback on this unit.

- If the date and time display and function indication are not wanted, cancel them before dubbing. (→ 49, 100)

If the dubbed images are played back on a wide-screen TV, the images may be stretched vertically.

In this case, refer to the operating instruction of the device you are connecting to or read the operating instructions of the wide-screen TV and set the aspect ratio to 16:9.

## With a printer (PictBridge)

### PHOTO

To print pictures by directly connecting this unit to the printer, use a printer compatible with PictBridge.

(Read the operating instructions for the printer.)

PictBridge is an industry standard from the Camera & Imaging Products Association (CIPA) for direct printing. It allows images to be printed directly from digital cameras to a printer, without having to connect the camera to a computer.

- Use the AC adaptor to free you from worrying about the battery running down.
- Insert an SD card with recorded images in this unit and then turn on the power.
- You cannot use in STD mode.

### 1 Connect this unit to a printer.

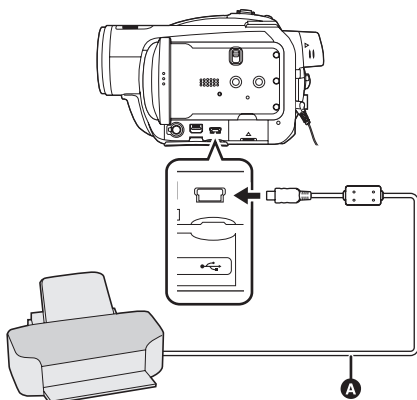

#### A USB cable (supplied)

The USB function selection screen will appear.

- Insert the plugs as far as they will go.
- Do not use any other USB connection cables except the supplied one. (Operation is not guaranteed with any other USB connection cables.)

### 2 Select [PictBridge] and press the cursor button.

The [PictBridge] indication appears on this unit's screen.

- If the [PictBridge] indication does not appear or continues to flash, disconnect and then

reconnect the USB cable or check the printer, SD card and settings on this unit.

### 3 Select a file to be printed, then press the cursor button.

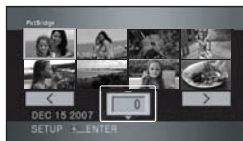

The number of prints set is displayed.

### 4 Move the cursor button up or down to select the desired number of prints, then press the cursor button.

- You can set up to 9 prints.
- To cancel the setting, set the number of prints to [0].
- Up to 8 files can be set in succession by repeating steps 3 and 4.

### 5 Press the MENU button to display the PictBridge menus.

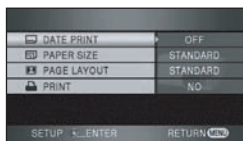

### 6 Select the date print setting on [DATE PRINT].



- If the printer is not capable of date printing, this setting is unavailable.

## 7 Select the paper size setting on [PAPER SIZE].

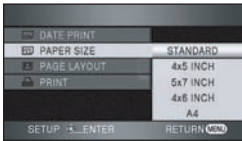

[STANDARD]: Size specific to the printer

[4x5 INCH]: L size

[5x7 INCH]: 2L size

[4x6 INCH]: Postcard size

[A4]: A4 size

- You cannot set paper sizes not supported on the printer.

## 8 Select the layout setting on [PAGE LAYOUT].



[STANDARD]: Layout specific to the printer

[No frame icon]: No frame print

[Frame icon]: Frame print

- You cannot set page layouts not supported on the printer.

## 9 Select [PRINT] → [YES] and press the cursor button to print the pictures.

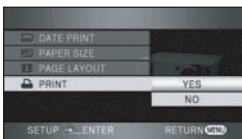

- Exit PictBridge by disconnecting the USB cable (supplied) after the pictures have been printed.

selected, all the settings are kept and the screen returns to step 4.

- Avoid the following operations during printing. These operations disable proper printing.
  - Disconnecting the USB cable
  - Opening the card slot cover and removing the SD card
  - Switching the mode dial
  - Turning off the power
- Check the settings for the paper size, quality of print, etc. on the printer.
- The edges of still pictures recorded in this unit with a 16:9 aspect ratio may be cut off. When using a printer with a trimming or borderless printing function, cancel this function before printing. (Refer to the operating instructions of the printer for details.)
- You may not be able to print still pictures recorded with other products.
- When the unit is connected directly to the printer, the DPOF settings cannot be used.
- Connect the printer directly to this unit. Do not use a USB hub.

### ***When you stop printing halfway***

Move the cursor button down.

- A confirmation message appears. If [YES] is selected, the number of prints set is canceled and the screen returns to step 3. If [NO] is

## With a computer

### *Before using with a computer*

#### What you can do with a computer

Data type	Available functions	Software used
Motion picture	Copying data to a computer	HD Writer 2.0E for SX/SD
	Writing data to media*	
	Copying data between media*	
	Playing back on a computer	
	Easy editing	
	Converting to MPEG2	
	Creating a DVD-Video disc	
Still picture	Playing back on a computer	Standard Windows picture viewer or a commercially available picture viewer
	Copying files to a computer	Windows Explorer
	Refer to P127 if using a Macintosh.	

\* Compatible media are SD card and discs (DVD-RAM, DVD-RW, DVD-R and DVD-R DL).

- Be sure to finalize all discs other than DVD-RAM on this unit before using them with a computer.
- You cannot write data to a disc when this unit is connected to a PC. Insert a media in the DVD writing drive on the computer and copy the data.
- Operation is not guaranteed when reading or writing motion picture data using software other than that supplied with this unit.
- Do not start the software supplied with this unit and other software at the same time. Close any other software if you start the software supplied with this unit and close the software supplied with this unit if you start any other software.
- Be sure to use the supplied USB cable when connecting this unit and a computer. (Operation is not guaranteed with any other USB cables.)



## Contents on provided CD-ROM

The following software applications are contained on the provided CD-ROM.

### ■ HD Writer 2.0E for SX/SD

You can acquire data of motion pictures and still pictures to the hard disk of the computer, easily edit (split, merge, delete) the motion pictures, then write the data to an SD card or disc.

- You cannot copy, play back, or create a DVD-Video from the data recorded in STD mode.



#### [Copy to PC]:

If you copy data to the hard disk of the computer, you can easily edit it (split, delete etc.).

#### [Write data to media]:

You can copy motion picture data and still picture data from the hard disk of the computer to an SD card. You can also copy motion picture data to a disc.

#### [Copy between media]:

You can copy motion picture data from an SD card to a disc or from a disc to an SD card.

#### [Easy editing]:

You can easily edit (split, merge, delete etc.) motion picture data that was copied to the hard disk of the computer. Also, you can convert data to MPEG2 format and create a DVD-Video.

#### [Start Playback]:

You can play back the images in high definition picture quality on a computer.

#### [Format disc]:

Depending on the type of disc that you use, formatting is necessary. Discs are formatted using the UDF 2.5 file system that supports the AVCHD format.

### ■ DirectX

If using Windows 2000, Microsoft DirectX 9.0c must be installed in order to operate the HD Writer 2.0E for SX/SD.

If DirectX is not already installed on your computer, you can install it from the CD-ROM. Click [DirectX] and follow the on-screen messages to install it. If you install the software on a computer that is not compatible with DirectX 9.0c, the computer may not work properly. If you are unsure whether or not your computer is compatible, contact the maker of your computer.

## End User License Agreement

Before opening the CD-ROM package, please read the following.

You ("Licensee") are granted a license for the Software defined in this End User Software Agreement ("Agreement") on condition that you agree to the terms and conditions of this Agreement. If Licensee does not agree to the terms and conditions of this Agreement, promptly return the Software to Matsushita Electric Industrial Co., Ltd. ("Matsushita"), its distributors or dealers from which you made the purchase.

### Article 1 License

Licensee is granted the right to use the software, including the information recorded or described on the CD-ROM, instruction manuals, and any other media provided to Licensee (collectively "Software"), but all applicable rights to patents, copyrights, trademarks and trade secrets in the Software are not transferred to Licensee.

### Article 2 Use by a Third Party

Licensee may not use, copy, modify, transfer or allow any third party, whether free of charge or not, to use, copy or modify the Software, except as expressly provided for in this Agreement.

### Article 3 Restrictions on Copying the Software

Licensee may make a single copy of the Software in whole or in part solely for back-up purposes.

### Article 4 Computer

Licensee may only use the Software on a single computer at a single location.

### Article 5 Reverse Engineering, Decompiling or Disassembly

Licensee may not reverse engineer, decompile, or disassemble the Software, except to the extent either of them is permitted under law or regulation of the country where Licensee resides. Matsushita, or its distributors or dealers will not be responsible for any defects in the Software or damage to Licensee caused by Licensee's reverse engineering, decompiling, or disassembly of the Software.

### Article 6 Limitation of Liability

The Software is provided "AS-IS" without warranty of any kind, either expressed or implied, including, but not limited to, warranties of non-infringement, merchantability and/or fitness for a particular purpose. Further, Matsushita does not warrant that the operation of the Software will be uninterrupted or error free. Matsushita or any of its distributors or dealers will not be liable for any damage suffered by Licensee arising from or in connection with Licensee's use of the Software.

### Article 7 Export Control

Licensee agrees not to export or re-export to any country the Software in any form without the appropriate export licenses under regulations of the country where Licensee resides, if necessary.

### Article 8 Termination of License

The right granted to Licensee hereunder will be automatically terminated if Licensee violates any of the terms and conditions of this Agreement. Upon such automatic termination, Licensee must destroy the Software and related documentation together with all the copies thereof at Licensee's own expense.

## Operating environment

- A CD-ROM drive is necessary to install the supplied software applications. (A compatible DVD writer drive and media are necessary for writing to a DVD.)
- When 2 or more USB devices are connected to a computer, or when devices are connected through USB hubs or by using extension cables, proper operation is not guaranteed.
- Use the supplied USB cable when connecting to the computer. (Operation is not guaranteed with any other USB cables.)
- Even if the system requirements mentioned in these operating instructions are fulfilled, some personal computers cannot be used.
- This software is not compatible with Microsoft Windows 3.1, Windows 95, Windows 98/98SE, Windows Me and Windows NT.
- Operation on an upgraded OS is not guaranteed.
- Operation on an OS other than the one pre-installed is not guaranteed.

### Operating environment for HD Writer 2.0E for SX/SD

<b>Personal computer</b>	IBM PC/AT compatible personal computer
<b>OS</b>	Microsoft Windows 2000 Professional Service Pack 4 Microsoft Windows XP Home Edition Service Pack 2 Microsoft Windows XP Professional Service Pack 2 Microsoft Windows Vista Home Basic Microsoft Windows Vista Home Premium Microsoft Windows Vista Ultimate
<b>CPU</b>	Intel Pentium III 1.0 GHz or higher (including compatible CPU) (Intel Core 2 Duo 1.86 GHz or higher or Intel Pentium D 3.0 GHz or higher is recommended when a playback function or MPEG2 output is used.)
<b>RAM</b>	Windows Vista: 1024 MB or more Windows XP/2000: 512 MB or more (1024 MB or more recommended)
<b>Display</b>	High Color (16 bit) or more (32 bit or more recommended) Desktop resolution of 1024×768 pixels or more (1280×1024 pixels or more recommended) Windows Vista: DirectX 10 compatible video card Windows XP/2000: DirectX 9.0c compatible video card Compatible with DirectDraw overlay PCI Express™×16 compatible recommended
<b>Free hard disk space</b>	Ultra DMA — 100 or more 250 MB or more (for installing the application) When writing to a DVD, more than double the amount of free space as the disc being created is necessary.
<b>Necessary software</b>	Windows Vista: DirectX 10 Windows XP/2000: DirectX 9.0c <ul style="list-style-type: none"> <li>• If you install the software on a computer that is not compatible with DirectX 9.0c, the computer may not work properly. If you are unsure whether or not your computer is compatible, contact the maker of your computer.</li> </ul> Adobe Acrobat Reader 5.0 or later or Adobe Reader 7.0 or later

## With a computer

<b>Sound</b>	DirectSound Support
<b>Interface</b>	USB port [Hi-Speed USB (USB 2.0)]
<b>Other requirements</b>	Mouse or equivalent pointing device

- Supplied CD-ROM is available for Windows only.
- Operation is not guaranteed on computers that are not PC/AT compatible.
- Input is not supported in languages other than English, French and Spanish.
- Operation cannot be guaranteed on all DVD drives.
- Discs recorded in AVCHD with this software cannot be played back on devices that do not support AVCHD.
- Operation is not guaranteed on Microsoft Windows XP Media Center Edition, Tablet PC Edition, Windows Vista Business/Enterprise and not compatible with 64 bit operation systems.
- This software is not compatible with a multi-boot environment.
- If using Windows XP/2000, an administrative account user only can use this software. If using Windows Vista, administrative account and standard account users only can use this software. (An administrative account user should install and uninstall this software.)
- This software is not compatible with a multi-CPU environment.
- If your computer does not satisfy the above system requirements, an error may occur when writing data to disc.
- Set the display resolution to 1024×768 (16 bits color) or higher.  
Select [start] → ([Settings] →) [Control Panel] → ([Appearance and Themes] →) [Display (Adjust screen resolution)] and select [Settings] tab, and then adjust [Screen resolution (Resolution)] and [Color quality (Colors)].

## ■ Operating environment for the card reader function (mass storage)

<b>Personal computer</b>	IBM PC/AT compatible personal computer
<b>OS</b>	Microsoft Windows 2000 Professional Service Pack 4 Microsoft Windows XP Home Edition Microsoft Windows XP Professional Microsoft Windows Vista Home Basic Microsoft Windows Vista Home Premium Microsoft Windows Vista Ultimate Microsoft Windows Vista Business Microsoft Windows Vista Enterprise
<b>CPU</b>	Windows Vista: Intel Pentium III 1.0 GHz or higher Windows XP/2000: Intel Pentium III 450 MHz or higher or Intel Celeron 400 MHz or higher
<b>RAM</b>	Windows Vista Home Basic: 512 MB or more Windows Vista Home Premium/Ultimate/Business/Enterprise: 1 GB or more Windows XP/2000: 128 MB or more (256 MB or more recommended)
<b>Interface</b>	USB port
<b>Other requirements</b>	Mouse or equivalent pointing device

- The USB equipment operates with the driver installed as standard in the OS.

## Installation

When installing the software, log on to your computer as the Administrator (or with a user name with equivalent authorization) or with the user name for a standard user account. (If you do not have authorization to do this, consult your manager.)

- Before starting the installation, close all the applications that are running.
- Do not perform any other operations on your computer while the software is being installed.

### Installing HD Writer 2.0E for SX/SD

#### 1 Insert the CD-ROM into the computer.



The [Setup Menu] screen will appear.

- If the [Setup Menu] screen does not appear, double-click the CD-ROM drive icon in [My Computer (Computer)].

#### 2 Click [HD Writer 2.0E for SX/SD].



- If using Windows 2000, Microsoft DirectX 9.0c must be installed in order to operate the HD Writer 2.0E for SX/SD. If you install the software on a computer that is not compatible with DirectX 9.0c, the computer may not work properly. If you are unsure whether or not your computer is compatible, contact the computer manufacturer.

#### 3 Click [Next].



#### 4 Read the End User License Agreement, then place a check beside [I accept the terms of the license agreement] if you agree to them and click [Next].



- If you do not agree to the terms and conditions of the License Agreement, installation is not possible.

#### 5 Continue to follow the on-screen messages to install it.

#### 6 After the installation is complete, restrictions are displayed.

**Check the contents, then close the window, by clicking [X] on the top right corner.**



## 7 Click [Finish].



The computer must be rebooted for the application to work.

## Reading the operating instructions of the software applications

For details on how to use the software applications, read the PDF operating instructions.

- You will need Adobe Acrobat Reader 5.0 or later or Adobe Reader 7.0 or later to read the PDF operating instructions.

Select [start] → [All Programs (Programs)] → [Panasonic] → [HD Writer 2.0E] → [Operating Instructions].



## Uninstalling software application

Follow the steps below to uninstall any software applications that you no longer require.

- 1 Select [start] → ([Settings] → [Control Panel] → [Add or Remove Programs (Applications)] or [Uninstall a program]).

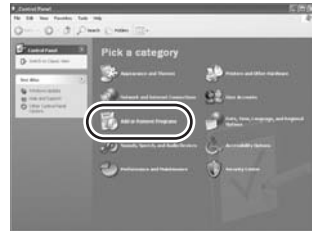

- 2 Select [HD Writer 2.0E for SX/SD], then click [Change/Remove] ([Change or Remove] or [Add/Remove]) or [Uninstall].



- Proceed with the uninstallation by following the on-screen instructions.
- After uninstalling the software, be sure to reboot the computer.

## Connection and recognition

### Camera–Computer connection

After the software applications are installed, this unit must be connected to the computer and be correctly recognized by the computer.

- Connect after installing the software applications.
- Remove the supplied CD-ROM if it is inserted in the computer. (If the [Setup Menu] screen is displayed, wait until it finishes and then remove the CD-ROM.)
- If the recognition procedure is not accomplished properly, operation will not be possible after connecting the unit to the computer.
- If the unit fails to operate normally, it may mean that you have not conducted the installation or recognition procedure properly.
- **Be sure to finalize all discs other than DVD-RAM before using them with a computer. Un-finalized discs cannot be recognized by the computer.**

#### 1 Connect this unit to the AC adaptor.

- If a battery is used, operation is not possible when this unit is connected to a computer.

#### 2 Insert a disc or card with recorded images in the unit, then turn on the unit.

#### 3 Connect this unit and a computer.

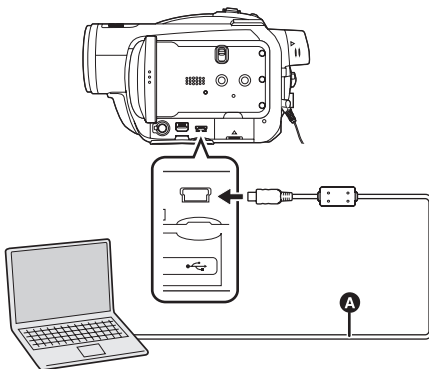

**A** USB cable (supplied)

The USB function selection screen will appear.

- Insert the plugs as far as they will go. The unit and computer will not operate properly if the plugs are not inserted fully.
- Do not use any other USB connection cables except the supplied one. (Operation is not guaranteed with any other USB connection cables.)

#### 4 Select [PC CONNECT (DISC)] or [PC CONNECT (CARD)] and then press the cursor button.

This unit is automatically recognized by the computer.

- **When the unit is connected to a computer, the operation mode cannot be changed and its power cannot be turned off. Disconnect the USB cable, before turning this unit off. (→ 121)**
- (STD mode) If the unit is connected to a computer when the USB function is set to [PC CONNECT (DISC)], no image will appear on the LCD monitor or the viewfinder.
- When this unit is connected to a computer, you cannot use this unit's DISC EJECT lever to remove a disc.
- Do not disconnect the USB cable or AC adaptor while the ACCESS/PC lamp is on or card access icon  appears on the LCD monitor. Doing so may damage the data on the disc or card.
- It may be necessary to reboot the computer after connecting this unit to it for the first time.

## About the computer display

When the unit is connected to a computer, it is recognized as an external drive.

### SD card drive display

- [Removable Disk] is displayed in [My Computer (Computer)].



#### Example folder structure of an SD card:

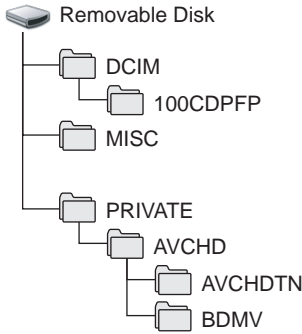

- AVCHD format motion picture files ([00000.MTS] etc.) are saved in the [BDMV] folder.
- The motion picture thumbnails are recorded in the [AVCHDTN] folder.
- JPEG format still pictures ([IMGA0001.JPG] etc.) are stored in the [100CDPFP] folder. These can be opened with picture software that supports JPEG pictures.
- Up to 999 files can be recorded in the [100CDPFP] or other such folder.
- The DPOF setting files are recorded in the [MISC] folder.

### Disk drive display

#### <HD mode>

[Optical Disk Drive] is displayed in [My Computer (Computer)], but it cannot be opened on computers that do not support the UDF 2.5.

#### Example folder structure of a disk:

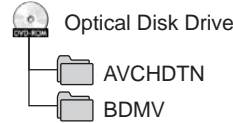

- AVCHD format motion picture files ([00000.MTS] etc.) are saved in the [BDMV] folder.
- The motion picture thumbnails are recorded in the [AVCHDTN] folder.
- The data cannot be written.

#### <STD mode>

Optical disc drive is displayed in [My Computer (Computer)].



- When a DVD-RAM or DVD-RW (VR format) is inserted in this unit, it can be accessed from the removable disk drive.



- When a DVD-RW (Video format) or DVD-R is inserted in this unit, it can be accessed from the optical disc drive.



#### Example folder structure of a DVD-RAM or DVD-RW (VR format):

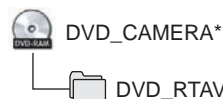

- DVD video recording format motion pictures are stored in the [DVD\_RTAV] folder.



### Example folder structure of a DVD-RW (Video format) or DVD-R:

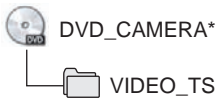

- DVD-Video format motion pictures are stored in the [VIDEO\_TS] folder.

\* Depending on the maker of the disc and the device used to format it, the name displayed will differ.

We recommend using HD Writer 2.0E for SX/SD to copy or write back motion picture data recorded in HD mode on a disc, an SD card or SD media storage.

Using Windows Explorer or other programs on the computer to copy, move or rename files and folders recorded with this unit will result in them being unusable with HD Writer 2.0E for SX/SD.

### ■ Copying your still pictures to your computer

#### Card reader function (mass storage)

When an SD card with recorded data on it is inserted into the unit and the unit is connected to a computer using a USB cable, the SD card can be used as an external drive so that still pictures on the card can be copied to the computer with Explorer or other programs.

#### 1 Connect this unit to the computer and then select [PC CONNECT (CARD)].

[Removable Disk] is displayed in [My Computer (Computer)].

#### 2 Double click the folder that contains the files on the removable disk ([DCIM] → [100CDPFP] etc.).

#### 3 Drag and drop the files onto the destination folder (on the computer hard disk).

- Do not use the computer to delete, move or rename the SD card's folders. Doing so may make the SD card unuseable in this unit.
- Always use this unit to format SD cards.
- When data not supported by this unit has been recorded on a computer, it will not be recognized by this unit.

### To disconnect USB cable safely

#### 1 Double click the ( ) icon in task tray displayed on the computer.

- Hardware disconnect dialogue appears.
- Depending on your computer's settings, this icon may not be displayed.

#### 2 Select [USB Mass Storage Device] and click [Stop].

##### When using a disc:

- Verify [MATSHITA HDC-SX5(DVD) USB Device] is selected and click [OK].

##### When using an SD card:

- Verify [MATSHITA HDC-SX5(SD) USB Device] is selected and click [OK].
- Click [Close], and you can safely disconnect the USB cable.

## Verifying the unit is correctly recognized by the computer

Connect the unit to the computer with a USB cable, select [PC CONNECT (DISC)] or [PC CONNECT (CARD)] on the USB function selection screen and then follow the steps below.

- With some computers including those made by NEC, the Device Manager may not be displayed if a mode that places restrictions on the functions has been established. Consult the manufacturer or follow the steps in your computer's operating instructions to establish a mode in which all the functions can be used, then proceed with operation.

- 1 (When using Windows XP/2000)  
Select [start] → ([Settings] →) [Control Panel] → ([Performance and Maintenance] →) [System].

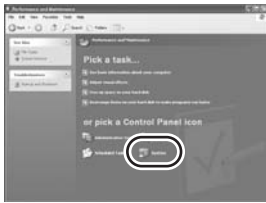

- (When using Windows Vista)
- 1 Select [start] → [Control Panel] → [System and Maintenance] → [Device Manager].

- 2 (When using Windows XP/2000)  
Click the [Hardware] tab, then click [Device Manager].

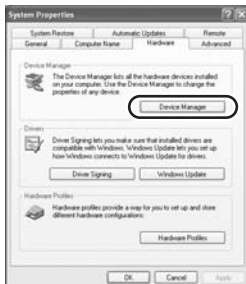

- 3 Verify the following items are displayed.



- If the driver has been recognized properly

When using a disc:

- [MATSHITA HDC-SX5(DVD) USB Device] is displayed at [DVD/CD-ROM drives].
- [USB Mass Storage Device] is displayed at [Universal Serial Bus controllers].

When using an SD card:

- [MATSHITA HDC-SX5(SD) USB Device] is displayed at [Disc drives].
- [USB Mass Storage Device] is displayed at [Universal Serial Bus controllers].

- If the driver has not been recognized properly

[!] or [Unknown device] appears at [Universal Serial Bus controllers] or [Other devices], etc. (Where the display will appear depends on the type of computer you are using.)

Use the following method to enable it to be recognized.

**Method 1:**

Turn off the unit and your computer once and try again.

**Method 2:**

Eject the disc or SD card and try verifying again.

**Method 3:**

Try connecting the unit to another USB port on your computer.

## Using HD Writer 2.0E for SX/SD

- When using HD Writer 2.0E for SX/SD on Windows XP/2000, log on to your computer as Administrator (or with a login name equally authorized). If you log on with a login name other than Administrator, you cannot use the applications.
- When using HD Writer 2.0E for SX/SD on Windows Vista, log on to your computer as Administrator (or with a login name equally authorized) or with the user name for a standard user account. If you log on with a user name for a guest user account, the software cannot be used.

### ■ Copying data on a disc or an SD card to the hard disk of the computer

#### 1 Connect this unit to the AC adaptor.

- If a battery is used, operation is not possible when this unit is connected to a computer.

#### 2 Insert a disc or card with recorded images in the unit, then turn on the unit.

#### 3 Connect this unit and a computer.

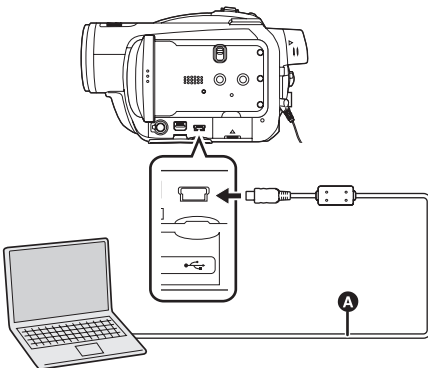

**A** USB cable (supplied)

The USB function selection screen will appear.

- Insert the plugs as far as they will go. The unit and computer will not operate properly if the plugs are not inserted fully.
- Do not use any other USB connection cables except the supplied one. (Operation is not guaranteed with any other USB cables.)

#### 4 Select [PC CONNECT (DISC)] or [PC CONNECT (CARD)] and then press the cursor button.

This unit is automatically recognized by the computer.

#### 5 (On the computer)

Select [start] →

[All Programs (Programs)] →

[Panasonic] → [HD Writer 2.0E]

→ [HD Writer].



The HD Writer 2.0E for SX/SD introductory screen is displayed. If [OK] is clicked, the software will start.

#### 6 Click the [Copy to PC] button.



#### 7 Click the [Start copying] button.



- A confirmation message appears. Click [Yes] and copying starts.

- After copying is complete, a message appears. If [Yes] is clicked, all the motion pictures and still pictures on the SD card will be deleted.
- If you switch from an SD card to a disc or a disc to an SD card, first disconnect and then reconnect the USB cable, click the [Refresh] button and then select [PC CONNECT (DISC)] or [PC CONNECT (CARD)] again.

## ■ Writing back to an SD card

- Insert an SD card in this unit and format the card. (→ 94)

(Use an SD card that can be used for motion picture recording. (→ 29))

Please be aware that if an SD card is formatted, then all the data recorded on the card will be erased. Store important data on a computer etc.

- Connect the AC adaptor to this unit.
- Connect this unit to the computer and start HD Writer 2.0E for SX/SD.

### 1 Click the [Write data to media] button.



### 2 Click on the top right and select the folder with the image data you want to copy to the SD card.



### 3 Select [Start writing] to copy the images from the hard disk of the computer to the SD card.



- A confirmation message appears. Click [Yes] and copying starts.

## ■ Playing back the high definition images on the computer

- Start HD Writer 2.0E for SX/SD.

### 1 Click the [Start Playback] button.



### 2 Select the media to be played back and then click [OK].

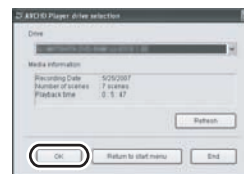

### 3 Select the scene to be played back and then click the [Play] button.



- The scenes from the selected one to the last one are played back on the full screen.
- Right click on the screen and then select [Stop] to stop playback.

## ■ Converting data that was copied to the hard disk of the computer to MPEG2 format

- The images are in conventional standard quality.
- You can record the converted data to a DVD disc using other DVD-Video writing software and then play it back on a DVD recorder etc.
- Start HD Writer 2.0E for SX/SD.

### 1 Click the [Easy editing] button.



### 2 Select the file to be converted into MPEG2 and then click the [Save as MPEG2] button.



### 3 Click [...], select the save destination, input the file name and then click the [Save] button.



### 4 Click the [Output the file] button.

- A confirmation message appears. Click [OK] and converting to MPEG2 starts.

## ■ Formatting a disc

- Format the disc on this unit or with [Format disc] in HD Writer 2.0E for SX/SD.
- Please be aware that if a disc is formatted, then all the data recorded on the disc is erased and cannot be recovered.

## ■ Creating a DVD-Video disc

You can create a disc (DVD-Video) that can be played back on conventional devices that do not support the AVCHD.

- The images are in conventional standard quality.
  - Insert an unused DVD-RW or DVD-R in a drive for DVD writing on the computer. DVD-RAM cannot be used.
  - You cannot record on a disc that has been already recorded on.
- However, you can record on a DVD-RW that has already been recorded on if you use HD Writer 2.0E for SX/SD to format it. Please be aware that if a disc is formatted, then all the data recorded on the disc is erased and cannot be recovered. Save important data on a computer etc.
- Start HD Writer 2.0E for SX/SD.

### 1 Click the [Select videos to copy to media] button on the [Easy editing] screen.



### 2 Select the desired scenes and then click the [Confirm selection] button.



**3** Insert the disc in a drive for writing, click  and then select the save destination.



**4** Click  and then select [DVD-Video (High quality)] or [DVD-Video (Standard quality)].



**5** Click the [Start Copy] button.

- A confirmation message appears. Click [OK] and creating the DVD-video starts.
  - It takes time to convert to MPEG2 format.
  - The disc created is a DVD-Video so it cannot be used with HD Writer 2.0E for SX/SD.
- 
- Refer to the operating instructions of the software (PDF file) for details on how to use it.
  - Do not insert a disc recorded in AVCHD format with HD Writer 2.0E for SX/SD in a device that does not support the AVCHD format. It may no longer be possible to eject it. Also, the disc cannot be played back on devices that do not support the AVCHD format.
  - Some discs recorded in AVCHD with HD Writer 2.0E for SX/SD may not be playable on other devices even if the other devices support AVCHD. In such cases, play them back on this unit instead.
  - The menu screen recorded in AVCHD with HD Writer 2.0E for SX/SD does not appear on this unit or HD Writer 2.0E for SX/SD. Use a device that supports AVCHD for playback.
  - Do not use Windows Explorer or other programs on the computer to copy, move or rename folders and files of motion picture data copied to the hard disk of the computer. They will become unusable with HD Writer 2.0E for SX/SD.

## If using a Macintosh

- Even if the system requirements mentioned in these operating instructions are fulfilled, some personal computers cannot be used.
- Apple, Mac OS is either registered trademarks or trademarks of Apple Inc. in the United States and/or other countries.
- PowerPC is a trademark of International Business Machines Corporation.

### ■ Operating environment for the card reader function (mass storage)

<b>Personal computer</b>	Macintosh
<b>OS</b>	Mac OS X v10.4
<b>CPU</b>	PowerPC G5 (1.8 GHz or higher) Intel Core Duo Intel Core Solo
<b>RAM</b>	64 MB or more
<b>Interface</b>	USB port

- The USB equipment operates with the driver installed as standard in the OS.
- Supplied CD-ROM is available for Windows only.

### ■ Copying still pictures on PC

#### 1 Connect this unit to a computer via the supplied USB cable.

- The USB function selection screen will appear.

#### 2 Select [PC CONNECT (CARD)] and press the cursor button.

#### 3 Double-click [NO\_NAME] or [Untitled] displayed on the desktop.

- Files are stored in [100CDPFP] folder etc. in the [DCIM] folder.

#### 4 Using a drag-and-drop operation, move the pictures you want to acquire or the folder storing those pictures to any different folder on the computer.

### ■ To disconnect USB cable safely

Drag [NO\_NAME] or [Untitled] disk icon to the [Trash], and then disconnect the USB cable.

## Others

### Menus and Indications

#### Menu list

#### HD mode recording menus

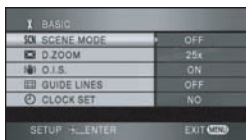

#### ■ [BASIC]

- [SCENE MODE] (→ 74)
- [D.ZOOM] (→ 62)
- [O.I.S.] (→ 69)
- [GUIDE LINES] (→ 70)
- [CLOCK SET] (→ 48)

#### ■ [VIDEO]

- [REC MODE] (→ 56)
- [FADE COLOR] (→ 64)
- [WIND CUT] (→ 71)
- [ZOOM MIC] (→ 62)
- [MIC LEVEL] (→ 71)
- [H.SHOE MIC] (→ 131)
- [AGS] (→ 52)

#### ■ [PICTURE]

- [PICT.QUALITY] (→ 60)
- [FLASH LEVEL] (→ 68)
- [SHTR SOUND] (→ 59)
- [RED EYE] (→ 68)

#### ■ [ADVANCED]

- [REC LAMP] (→ 131)
- [ZEBRA] (→ 72)
- [COLOR BAR] (→ 73)
- [MF ASSIST] (→ 75)
- [AUTO SLOW SHTR] (→ 73)

#### ■ [SETUP]

- [FORMAT DISC] (→ 93)<sup>\*1</sup>
- [AUTO PROTECT] (→ 97)<sup>\*1</sup>
- [FORMAT CARD] (→ 94)
- [DISPLAY] (→ 131)
- [DATE/TIME] (→ 49)
- [DATE FORMAT] (→ 49)
- [POWER SAVE] (→ 131)
- [QUICK START] (→ 38)<sup>\*2</sup>
- [BEEP SOUND] (→ 132)
- [LCD SET] (→ 49)
- [EVF SET] (→ 49)
- [COMPONENT OUT] (→ 105)
- [HDMI RESOLUTION] (→ 102)
- [EZ Sync] (→ 103)
- [TV ASPECT] (→ 107)
- [INITIAL SET] (→ 132)
- [DEMO MODE] (→ 132)

#### ■ [LANGUAGE] (→ 46)

- \*1 Disc recording mode only
- \*2 SD card recording mode only



## STD mode recording menus

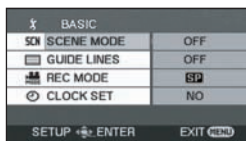

### ■ [BASIC]

[SCENE MODE] (→ 74)

[GUIDE LINES] (→ 70)

[REC MODE] (→ 56)

[CLOCK SET] (→ 48)

### ■ [ADVANCED]

[D.ZOOM] (→ 62)

[O.I.S.] (→ 69)

[FADE COLOR] (→ 64)

[REC LAMP] (→ 131)

[WIND CUT] (→ 71)

[ZOOM MIC] (→ 62)

[H.SHOE MIC] (→ 131)

### ■ [DISC SETUP]

[FORMAT DISC] (→ 93)

[INFORMATION] (→ 99)

### ■ [SETUP]

[DISPLAY] (→ 131)

[DATE/TIME] (→ 49)

[DATE FORMAT] (→ 49)

[POWER SAVE] (→ 131)

[AGS] (→ 52)

[BEEP SOUND] (→ 132)

[LCD SET] (→ 49)

[EVF SET] (→ 49)

### ■ [LANGUAGE] (→ 46)

## HD mode playback menus

(▶ motion picture playback)

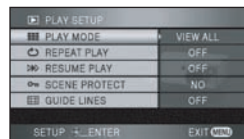

### ■ [PLAY SETUP]

[PLAY MODE] (→ 83)

[REPEAT PLAY] (→ 80)

[RESUME PLAY] (→ 83)

[SCENE PROTECT] (→ 88)

[GUIDE LINES] (→ 70)

### ■ [EDIT SCENE]

[DIVIDE] (→ 87)

[DELETE] (→ 86)

### ■ [DISC COPY]\*1

[COPY ALL] (→ 89)

[COPY SELECT] (→ 89)

### ■ [DISC SETUP]\*2

[FORMAT DISC] (→ 93)

[FINALIZE]

(When using a DVD-RW, DVD-R or DVD-R DL)  
(→ 94)

[CREATE TOP MENU]

(When using a DVD-RAM) (→ 96)

[UN-FINALIZE] (→ 96)

[AUTO PROTECT] (→ 97)

[INFORMATION] (→ 99)

\*1 When selecting the [▶] (motion picture playback) tab

\*2 When selecting the [●] (motion picture playback) tab

■ [SETUP]

- [FORMAT CARD] (→ 94)
- [DISPLAY] (→ 131)
- [DATE/TIME] (→ 49)
- [DATE FORMAT] (→ 49)
- [POWER SAVE] (→ 131)
- [BEEP SOUND] (→ 132)
- [LCD SET] (→ 49)
- [EVF SET] (→ 49)
- [COMPONENT OUT] (→ 105)
- [HDMI RESOLUTION] (→ 102)
- [EZ Sync] (→ 103)
- [TV ASPECT] (→ 107)

■ [LANGUAGE] (→ 46)

HD mode playback menus

(▶ still picture playback)



■ [PLAY SETUP]

- [SCENE PROTECT] (→ 91)
- [DPOF SET] (→ 92)

■ [SETUP]

- [FORMAT CARD] (→ 94)
- [DISPLAY] (→ 131)
- [DATE/TIME] (→ 49)
- [DATE FORMAT] (→ 49)
- [POWER SAVE] (→ 131)
- [BEEP SOUND] (→ 132)
- [LCD SET] (→ 49)
- [EVF SET] (→ 49)
- [COMPONENT OUT] (→ 105)
- [HDMI RESOLUTION] (→ 102)
- [EZ Sync] (→ 103)
- [TV ASPECT] (→ 107)

■ [LANGUAGE] (→ 46)

## STD mode playback menus (▶ motion picture playback)

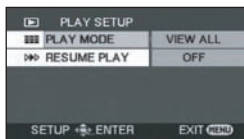

### ■ [PLAY SETUP]

[PLAY MODE] (→ 83)

[RESUME PLAY] (→ 83)

### ■ [EDIT SCENE]

[DIVIDE] (→ 87)

[DELETE] (→ 86)

### ■ [DISC SETUP]

[FINALIZE] (→ 94)

[UN-FINALIZE] (→ 96)

[DISC PROTECT] (→ 98)

[FORMAT DISC] (→ 93)

[INFORMATION] (→ 99)

### ■ [SETUP]

[DISPLAY] (→ 131)

[DATE/TIME] (→ 49)

[DATE FORMAT] (→ 49)

[POWER SAVE] (→ 131)

[BEEP SOUND] (→ 132)

[LCD SET] (→ 49)

[EVF SET] (→ 49)

[TV ASPECT] (→ 107)

### ■ [LANGUAGE] (→ 46)

## Menus related to [VIDEO] and [ADVANCED]

### ■ [H.SHOE MIC]

- [NORMAL]
- [LOWCUT]

Set to [LOWCUT] and this reduces low sound noise and wind noise hitting the stereo zoom microphone (VW-VMH3; optional) mounted on the smart accessory shoe.

### ■ [REC LAMP]

- [OFF]
- [ON]

The recording lamp lights during recording and flashes when the unit receives a signal from the remote control or when the self-timer is counting down. When this is set to [OFF], it does not light during recording.

## Menus related to [SETUP]

### ■ [DISPLAY]

- [OFF]
- [ON]

The screen indications are selected as shown in the illustration below.

[OFF]

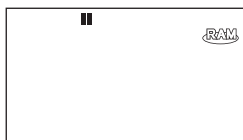

[ON]



### ■ [POWER SAVE]

- [OFF]
- [5 MINUTES]

[OFF]:

The power saving function is not activated.

[5 MINUTES]:

When about 5 minutes have passed without any operation, this unit automatically turns off to save battery life. To use this unit turn it on again.

- In the following cases, the unit may not turn off even when you set this to [5 MINUTES].
  - When using the AC adaptor
  - When connecting the unit to a computer or printer via the USB cable
  - When PRE-REC is used

**[BEEP SOUND]**

- [OFF]                      • [ON]

This allows operations such as starting and ending recording to be signaled by a beep. When [OFF] is set, no beep is heard when an operation such as recording is started or ended.

**1 Beep**

When you start recording  
 When you turn on the power  
 When this unit is recognized by the computer or the printer, etc.

**2 Beeps**

When you pause recording  
 When you turn off the power

**2 Beeps/4 times**

When an error occurs e.g. recording not starting. Check the sentence displayed on the screen. (→ 135)



**[INITIAL SET] (HD mode only)**

- [YES]                      • [NO]

When there is a menu that cannot be selected due another function or mode being activated, set to [YES] for changing the menu settings back to the default condition. (The language setting cannot be changed back to the default condition.)

**[DEMO MODE] (HD mode only)**

- [OFF]                      • [ON]

This item is used to start the unit demonstration. (Only when the mode dial is at the  or  position) If you set this to [ON] without inserting a disc or an SD card, this unit is automatically set to the demonstration mode for introducing its functions. If any button is pressed or operated, the demonstration mode is canceled. If no operations take place for approx. 10 minutes, the demonstration mode automatically starts. To terminate the demonstration mode, insert a disc or an SD card, or set this to [OFF]. For normal use, set this function to [OFF].

**Indications**

**Recording indications**



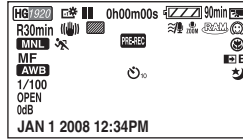

**Motion picture recording**



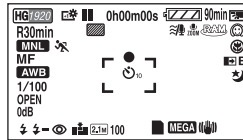















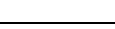





























**Still picture recording**

(when the PHOTO SHOT button is pressed halfway)



	Remaining battery power
<b>90min</b>	Remaining time for battery power
<b>R30min</b>	Remaining time for motion picture recording
<b>0h00m00s</b>	Elapsed recording time
<b>JAN 1 2008</b>	Date indication
<b>12:34PM</b>	Time indication
<b>●/II (Red)</b>	Recording/writing to a disc or an SD card
<b>II (Green)</b>	Recording pause
<b>AUTO</b>	Auto mode
<b>MNL</b>	Manual mode
<b>MF</b>	Manual focus
<b>10×</b>	Zoom magnification indication
	Backlight compensation
	Image stabilizer
	POWER LCD EXTRA
<b>1/100</b>	Shutter speed
<b>OPEN, F2.0</b>	F number
<b>0dB</b>	Gain value
<b>PRE-REC</b>	PRE-REC
	Intelligent contrast control

	Soft skin mode
	Tele macro
	Fade (White), Fade (Black)
	MagicPix function
	Zoom microphone
	Wind noise reduction
	External microphone supporting the smart accessory shoe
	External microphone supporting the smart accessory shoe (LOW CUT)
	Microphone level
	Zebra display
	HG mode
	HN mode
	HE mode
	XP mode
	SP mode
	LP mode
	Sports mode
	Portrait mode
	Low light mode
	Spotlight mode
	Surf & snow mode
	Auto white balance
	Indoor mode (recording under incandescent lamp)
	Outdoor mode
	Manual adjustment mode
	<b>Disc type</b>
	DVD-RAM
	DVD-RW
	DVD-RW (VR format)
	DVD-RW (Video format)
	DVD-RW (unformatted)
	DVD-R
	DVD-R DL
	(dual layer on single side)

	Flash
	Flash level
	Red eye reduction
	Focus indication
	Self-Timer recording
	MEGA OIS
	Number of recording pixels for still pictures 1920×1080
	Card can be recorded to
	Recognizing the card
	Recording/accessing the card
	Still picture quality
	Remaining number of still pictures

## ■ Playback indications

### Motion picture playback

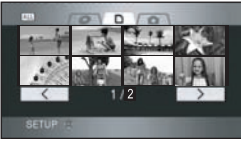

### Still picture playback



	Playback
	Pause
	Fast forward/rewind playback
	Last/first scene paused
	Skip playback
	Slow motion playback
	Frame-by-frame playback
<b>0h00m00s</b>	Playback time
	<b>Play mode</b>
	All scenes on the disc or SD card
	Scenes recorded on the selected date
	Number of recording pixels for motion pictures
	1920×1080
	1440×1080
<b>No.10</b>	Scene number
	Volume adjustment
	Repeat playback
	Resume playback
<b>100-0001</b>	Still picture folder/file number display
<b>PictBridge</b>	When a printer compatible with PictBridge is connected

	DPOF already set (to more than 1)
	Contents that have been protected.
	Number of recording pixels for still pictures 1920×1080
The picture size is not displayed for still pictures recorded with other products that have different picture sizes from the sizes shown above.	

## ■ PC connection indications

	Accessing the card (When connected to a computer)
--	--

## ■ Confirmatory indications

	(Time display) The built-in battery is low. (→ 49)
	The warning/alarm indication appears when LCD monitor is rotated towards the lens side. Return the direction of the LCD monitor to normal position and check the warning/alarm indication.
	No disc is inserted.
	Unusable disc
	No card is inserted.

## Messages

<b>CANNOT RECORD.</b>	Data writing to the disc or SD card has failed.
<b>NO DATA.</b>	There are no images recorded on the disc or SD card. If this message appears although data is recorded on the SD card, the condition of the card is probably not stable. Turn off the power and then turn it on again.
<b>CANNOT BE USED DUE TO INCOMPATIBLE DATA.</b>	The recording format is different so it cannot be used.
<b>CANNOT RECORD -INCOMPATIBLE CONTROL DATA.</b>	Insert a new disc or save the data on the SD card to a computer and then format the SD card before using it.
<b>THIS DISC IS INCOMPATIBLE.</b>	You inserted an incompatible disc (copy-protected discs, etc.).
<b>PLEASE CHECK THE DISC.</b>	You inserted a disc that cannot be read on this unit, or the disc has been protected (write-protect).
<b>THIS IS A NON-RECORDABLE DISC.</b>	The disc cannot be used for recording on this unit. Insert a new disc.
<b>RECOMMENDED TO USE PANASONIC DISC</b>	You inserted a disc that does not meet the DVD standard for quality and performance so you may not be able to record normally.
<b>CANNOT RECORD. (THIS DISC IS FINALIZED)</b>	A finalized DVD-RW (HD mode)/DVD-RW (Video format/STD mode) or DVD-R, DVD-R DL has been inserted. After finalizing, the discs become play-only and cannot record. If you un-finalize a DVD-RW (HD mode)/DVD-RW (Video format/STD mode), it can be used for recording. (→ 96)
<b>CANNOT RECORD. THE NUMBER OF SCENES HAS EXCEEDED THE MAXIMUM LIMIT.</b>	The disc or SD card is full or the number of scenes has reached the maximum limit so no further data can be recorded. Delete unnecessary scenes (→ 86) or insert a new disc or SD card.
<b>CANNOT RECORD - DATE CAPACITY IS FULL.</b>	The scenes grouped by date have reached the maximum number of dates so recording is not possible. Delete unnecessary scenes (→ 86) or insert a new disc or SD card.
<b>NO NEED TO FORMAT THIS DISC.</b>	DVD-R and DVD-R DL can only be recorded on once so cannot be formatted.
<b>THE DISC IS FINALIZED.</b>	A finalized disc has been inserted. DVD-R and DVD-R DL cannot be un-finalized. If you un-finalize a DVD-RW, it can be used for recording again. (→ 96)
<b>CANNOT FINALIZE.</b>	The disc cannot be finalized (un-finalized) on this unit. (The disc was recorded on another device etc.) Or, you are trying to finalize a disc that has no motion pictures recorded on it.

<b>CANNOT READ DISC. PLEASE CHECK CONDITION OF DISC.</b>	There are scratches or dirt on the recording/playback side of the disc. If there is dirt on the disc, use a soft cloth to wipe it. (→ 30) If the disc is scratched, insert a new one.
<b>CHECK CARD.</b>	This card is not compatible or it cannot be recognized by the unit.
<b>THIS CARD CANNOT RECORD IN VIDEO MODE.</b>	An 8 MB or 16 MB SD card on which motion pictures cannot be recorded is inserted.
<b>CARD LOCKED.</b>	The write protection switch on the SD card is set to LOCK. (→ 29)
<b>NOW ACCESSING. PLEASE DO NOT REMOVE CARD.</b>	The data is being processed. Close the card slot cover and wait for a while.
<b>CARD FULL.</b>	The SD card is full so no further data can be recorded. Delete unnecessary files (→ 86, 90) or insert a new SD card.
<b>CANNOT OPERATE THIS FUNCTION IN THIS MODE.</b>	PRE-REC cannot be set in disc recording mode. Or, you are trying to copy a disc in STD playback mode.
<b>TOP MENU COULD NOT BE CREATED.</b>	Creating a top menu has failed. There may be scratches or dirt on the recording/playback side of the disc. If there is dirt on the disc, use a soft cloth to wipe it. (→ 30)
<b>CANNOT DIVIDE. THE NUMBER OF SCENES IS FULL.</b>	The disc or SD card is full or the number of scenes has reached the maximum limit so no further data can be divided. Delete unnecessary scenes (→ 86).
<b>CANNOT OPERATE. TEMPERATURE IS HIGH.</b>	The temperature of the unit is high so it cannot be operated. Turn off the power, wait until the unit cools and then turn on the power again.
<b>CANNOT OPERATE. TEMPERATURE IS HIGH. PLEASE TURN OFF AND WAIT A WHILE.</b>	
<b>THIS BATTERY CANNOT BE USED.</b>	Use a battery that is compatible with this unit. (→ 32) You are attempting to connect an AC adaptor not compatible with this unit. Use the supplied AC adaptor. (→ 35) If using a Panasonic battery compatible with this unit (→ 32), eject the battery and then insert it again. If the message appears even after repeating this several times, this unit needs repair. Detach the power and consult the dealer who you purchased this unit from. Do not attempt to repair it by yourself.
<b>AGS MODE ON-REC PAUSED</b>	The AGS function is activated. (→ 52)
<b>PUSH THE RESET SWITCH.</b>	An irregularity in the unit has been detected. Press the RESET button to restart the unit. (→ 145)
<b>CHECK THE DISC AFTER PUSHING THE RESET SWITCH TO REPAIR THE DATA.</b>	There may be scratches or dirt on the recording/playback side of the disc. If there is dirt on the disc, use a soft cloth to wipe it. (→ 30) If the disc is scratched, insert a new one.



<b>CANNOT SET.</b>	The [GUIDE LINES], [ZEBRA], [MF ASSIST], [MIC LEVEL] and [RED EYE] menu settings cannot be set when the color bar is set.
<b>DISCONNECT USB CABLE.</b>	The unit cannot correctly establish the connection to the computer or printer. Disconnect and then reconnect the USB cable.
<b>(HD mode) DISCONNECT USB CABLE.</b>	The unit's power cannot be turned off when the unit is connected to the computer.
<b>(STD mode) CANNOT OPERATE WHILE CONNECTED TO COMPUTER.</b>	

## About recovery

It is possible that the system cannot complete writing of a file normally when, for example, power is turned off for some reason during recording or editing.

If faulty management information is found when a disc or an SD card is accessed, the following message may appear. (Repairing may take time depending on the error.)

### ◇ HD mode

**CONTROL DATA ERROR HAS BEEN DETECTED.**

**When connecting to AC adaptor or the remaining capacity of the battery is enough:**  
[FINISHED.]

**When the remaining capacity of the battery is low:**  
[CANNOT REPAIR CONTROL INFORMATION DUE TO LOW BATTERY POWER.]

**THUMBNAIL DATA ERROR IS DETECTED.**

**When connecting to AC adaptor or the remaining capacity of the battery is enough:**  
[THUMBNAIL DATA HAS BEEN REPAIRED SUCCESSFULLY.]

**When the remaining capacity of the battery is low:**  
[CANNOT REPAIR CONTROL INFORMATION DUE TO LOW BATTERY POWER.]

### ◇ STD mode

**DISC ERROR HAS OCCURRED. NOW REPAIRING DATA ON THE DISC.**

- Use a sufficiently charged battery or the AC adaptor.
- Depending on the condition of the data, it may not be possible to completely repair the data.
- If the recovery fails, you will no longer be able to playback the data recorded before the power went off.
- When data recorded on another device is recovered, it may not be possible to play back the data on this unit or the other device.
- If the thumbnail information is recovered, displaying the thumbnails may become slower.

## ***Functions that cannot be used simultaneously***

Some functions in this unit are disabled or cannot be selected due to the unit's specifications. The table below shows examples of functions restricted by various conditions.

<b>Functions</b>	<b>Conditions which disable the functions</b>
<b>Backlight compensation</b>	<ul style="list-style-type: none"> <li>● When the MagicPix function is used</li> <li>● When the iris/gain is set</li> </ul>
<b>Intelligent contrast control</b>	
<b>MagicPix (Set and cancel)</b>	<ul style="list-style-type: none"> <li>● While recording</li> <li>● When PRE-REC is used</li> </ul>
<b>Soft skin mode (Set and cancel)</b>	
<b>Tele macro (Set and cancel)</b>	
<b>Help mode</b>	
<b>Self timer</b>	
<b>Red eye reduction</b>	
<b>Fade</b>	
<b>Shutter effect</b>	<ul style="list-style-type: none"> <li>● While motion pictures recording</li> <li>● When PRE-REC is used</li> </ul>
<b>Flash</b>	<ul style="list-style-type: none"> <li>● While motion pictures recording</li> <li>● When PRE-REC is used</li> <li>● When the MagicPix function is used</li> </ul>
<b>Zoom</b>	<ul style="list-style-type: none"> <li>● When the PHOTO SHOT button is pressed halfway in still picture recording</li> </ul>
<b>Zoom microphone</b>	<ul style="list-style-type: none"> <li>● An external microphone is used</li> </ul>
<b>Wind noise reduction</b>	
<b>Scene mode</b>	<ul style="list-style-type: none"> <li>● When setting the AUTO/MANUAL/FOCUS switch to AUTO</li> <li>● When the MagicPix function is used</li> </ul>
<b>MF assist function</b>	<ul style="list-style-type: none"> <li>● When digital zoom (10× or higher) is used</li> </ul>
<b>Change of white balance</b>	<ul style="list-style-type: none"> <li>● When digital zoom (10× or higher) is used</li> <li>● When the MagicPix function is used</li> </ul>
<b>Adjusting the shutter speed, iris/gain</b>	<ul style="list-style-type: none"> <li>● When the MagicPix function is used</li> <li>● When the scene mode is used</li> </ul>

---

## Frequently asked questions

---

### ? What kind of discs can be used?



DVD-RAM, DVD-RW, DVD-R and DVD-R DL can be used if they are 8 cm (3") bare discs. (→ 24)

### ? Can discs with a cartridge be used?



They can be used if the cartridge is removed.

### ? Can double sided discs be used?



They can be used.

However you cannot record or play continuously from one side of the disc to the other. You will need to eject the disc and turn it over.

### ? Can I record continuously from one side of the disc to the other on a double sided disc?



You cannot record continuously from one side of the disc to the other. The recording time indicated on the disc package is the total time for both sides. You will need to eject the disc and turn it over to record on both sides.

### ? Can DVD-R or DVD-R DL be recorded to once only?



Recording can be started and stopped until the disc is full.

(HD mode) The remaining space on the disc will not increase even if recorded scenes are deleted.

(STD mode) Once data is recorded it cannot be deleted.

### ? Is playback possible on a DVD player?

#### HD mode:

To playback a disc recorded on this unit, you will need a playback device that supports AVCHD.

Also if a DVD-RW, DVD-R or DVD-R DL recorded on this unit is inserted in another device without it being finalized, it may no longer be possible to use the disc. Always finalize the disc on this unit before inserting it in another device.



#### STD mode:

By finalizing a DVD-RW (VR format/Video format) or a DVD-R in this unit, it can be played back on a DVD player.

To playback a DVD-RAM, DVD-RW (VR format) or DVD-R DL, you will need a DVD recorder or a DVD player that supports DVD-RAM, DVD-RW (VR format) or DVD-R DL. Refer to the operating instructions of the DVD recorder or DVD player.

### ? Can I use computer software other than that supplied?



For information about software from other companies, contact the makers of the software.



---





## Troubleshooting

### Unit operations

Problem	Check points
<b>This unit cannot be turned on.</b>	<ul style="list-style-type: none"> <li>● Is the battery fully charged? → Charge the battery using the AC adaptor. (→ 31)</li> <li>● The battery protection circuit may have operated. Attach the battery to the AC adaptor for 5 to 10 seconds. If the unit still cannot be used, the battery is faulty.</li> <li>● Make sure the LCD monitor is opened or the viewfinder extended.</li> </ul>
<b>This unit is turned off automatically.</b>	<ul style="list-style-type: none"> <li>● If you do not use the unit for approximately 5 minutes, the power is automatically turned off to conserve battery life. To resume recording, turn the power back on. The power will not turn off automatically when the power save function is set to [OFF]. (→ 131)</li> <li>● Are you connecting to a TV compatible with EZ Sync with a HDMI cable? → If you connect to a TV compatible with EZ Sync with a HDMI cable and turn off the power on the TV with the remote control for the TV, the power on this unit also turns off. If you are not using EZ Sync, set [EZ Sync] to [OFF]. (→ 103)</li> </ul>
<b>This unit does not stay on long enough.</b>	<ul style="list-style-type: none"> <li>● Is the battery low? → If the remaining battery power indication is flashing or the message "CHANGE THE BATTERY." is displayed, the battery has run down. Charge the battery. (→ 31)</li> </ul>
<b>Battery runs down quickly.</b>	<ul style="list-style-type: none"> <li>● Is the battery fully charged? → Charge it with the AC adaptor. (→ 31)</li> <li>● Are you using the battery in an extremely cold place? → The battery is affected by ambient temperature. In cold places, battery life becomes shorter.</li> <li>● Has the battery worn out? → The battery has a limited life. If the operating time is still too short even after the battery is fully charged, the battery has worn out and needs to be replaced.</li> </ul>
<b>The minute display of the remaining battery power indication is not displayed correctly.</b>	<ul style="list-style-type: none"> <li>● The remaining battery capacity indication is an approximation. If you think the remaining battery capacity indication is not displayed correctly, fully charge the battery, discharge it and then charge it again. (Even if this operation is performed, it may not be possible to display the remaining battery capacity correctly if the battery was used for a long period of time where the temperature was low or high or if the battery was repeatedly charged.)</li> </ul>

Problem	Check points
<p><b>This unit cannot be operated though it is turned on.</b></p> <p><b>This unit does not operate normally.</b></p>	<ul style="list-style-type: none"> <li>● The unit cannot be operated unless you open the LCD monitor or extend the viewfinder.</li> <li>● Press the RESET button. (→ 145) If normal conditions are not restored yet, remove the battery or AC adaptor, wait about 1 minute and then reconnect the battery or AC adaptor. Then about 1 minute later, turn on the power again. (Conducting the above operation when the access lamp is on may destroy the data on the disc or SD card.)</li> </ul>
<p><b>The remote control does not function.</b></p>	<ul style="list-style-type: none"> <li>● Has the button-type battery of the remote control run out? → Replace it with a new button-type battery. (→ 22)</li> </ul>
<p><b>The message “DISC DOOR OPENED.” appears although the disc cover is closed.</b></p>	<ul style="list-style-type: none"> <li>● This message may appear if the battery is removed or the AC adaptor is disconnected while removing a disc or before the power to the unit fully turns off. → Open the disc cover with the DISC EJECT lever and then close it again.</li> </ul>
<p><b>The DISC EJECT lever does not work.</b></p>	<ul style="list-style-type: none"> <li>● The disc cover will not open unless the unit is powered. → Connect a charged battery or AC adaptor.</li> <li>● The DISC EJECT lever does not work when the unit is connected to the computer. → Disconnect the USB cable.</li> </ul>
<p><b>The screen has changed suddenly.</b></p>	<ul style="list-style-type: none"> <li>● Has the demonstration started? → If you set [DEMO MODE] to [ON] without inserting a disc or an SD card in recording mode, the unit is automatically set to the demonstration mode for introducing its functions. Normally this should be set to [OFF]. Press the MENU button, then select [SETUP] → [DEMO MODE] → [OFF] and press the cursor button.</li> </ul>
<p><b>A function indication such as the remaining time indication or the elapsed time indication is not shown.</b></p>	<ul style="list-style-type: none"> <li>● If you set [SETUP] → [DISPLAY] → [OFF], all indications other than warnings and date are not displayed.</li> </ul>

Problem	Check points
<b>The disc cannot be read.</b>	<ul style="list-style-type: none"> <li>● Are there fingerprints or dirt on the surface of the disc? → If there are fingerprints or dirt on the disc, wipe them off. (→ 30)</li> </ul>
<b>Recording does not start although power is supplied to this unit and the disc or SD card is correctly inserted.</b>	<ul style="list-style-type: none"> <li>● (HD mode) Has the DVD-RW, DVD-R or DVD-R DL been finalized? → After finalizing, the discs become play-only and cannot record. If you un-finalize a DVD-RW, it can be used for recording. (→ 96)</li> <li>● (STD mode) Is the DVD-RAM or the DVD-RW (VR format) write-protected? → Release the protection. (→ 98) If the DVD-RAM or DVD-RW (VR format) was protected on another device, release the protection on the same device.</li> <li>● (STD mode) Has the DVD-RW (Video format) or DVD-R been finalized? → After finalizing, the discs become play-only and cannot record. If you un-finalize a DVD-RW (Video format), it can be used for recording. (→ 96)</li> <li>● Has the SD card's write protect switch been set to LOCK? → No recording is possible while the write protect switch is set to LOCK. (→ 29)</li> <li>● Is the memory of the disc or SD card full? → If the disc or SD card has no more available memory, free up some memory by deleting unnecessary scenes (→ 86, 90) or use a new disc or SD card.</li> <li>● Is the unit set to the recording mode? → No recording is possible unless the mode dial is at  or .</li> <li>● Is the disc cover or card slot cover open? → If the disc cover or card slot cover is open, this unit may not operate normally. Close the disc cover or card slot cover.</li> </ul>
<b>Recording starts but stops immediately.</b>  <b>The playback picture breaks up for a moment.</b>	<ul style="list-style-type: none"> <li>● Is the disc scratched or dirty? → Wipe off the dirt on the disc. (→ 30) If the disc is scratched, insert a new one.</li> <li>● The unit is hot. Follow the messages on the display. To use the unit again, turn the unit off and leave it for a while.</li> </ul>
<b>The unit arbitrarily stops recording.</b>	<ul style="list-style-type: none"> <li>● Can the SD card be used for motion picture recording? → Use an SD card that can be used for motion picture recording. (→ 29)</li> <li>● Is the AGS function activated? → Record in the normal horizontal position or set [AGS] to [OFF]. (→ 52)</li> </ul>
<b>Auto focus function does not work.</b>	<ul style="list-style-type: none"> <li>● Is manual focus mode selected? → Set the AUTO/MANUAL/FOCUS switch to AUTO.</li> <li>● Are you trying to record a scene which is hard to bring into focus in auto focus mode? → There are some recording subjects and surroundings for which the auto focus does not operate correctly. (→ 155) If so, use the manual focus mode to adjust the focus. (→ 75)</li> </ul>

Problem	Check points
Recorded still pictures are not clear.	<ul style="list-style-type: none"> <li>● Are you trying to record small or finely detailed objects with [PICT.QUALITY] set at [  ]? → If you try to record small or finely detailed objects with [PICT.QUALITY] set at [  ], the images may break up into a mosaic-like pattern. Record with [PICT.QUALITY] set at [  ] instead. (→ 60)</li> </ul>
Sound is not played back from the built-in speaker of this unit.	<ul style="list-style-type: none"> <li>● Is the volume too low? → During playback, move the volume lever to display the volume indication and adjust it. (→ 83)</li> </ul>
Although this unit is correctly connected to a TV, images cannot be seen.  The images are squeezed horizontally.	<ul style="list-style-type: none"> <li>● Does the input switch on the TV match the connected terminal? → Please read the operating instructions of your TV and select the channel that matches the input used for the connection.</li> <li>● Is the [TV ASPECT] setting correct? → Change the setting to match the aspect ratio of the TV. Press the MENU button, then select [SETUP] → [TV ASPECT] → [16:9] or [4:3] and press the cursor button.</li> <li>● If both HDMI and component cables are connected, priority in recording mode is given to the output from the HDMI cable. If you set the unit to playback mode, output is from both cables.</li> <li>● Pictures recorded in STD mode cannot be played back using the HDMI or component cables. Use the AV cable to play back pictures recorded in STD mode.</li> </ul>
Scenes cannot be deleted or edited.	<ul style="list-style-type: none"> <li>● (STD mode) Is the DVD-RAM or the DVD-RW (VR format) write-protected? → Release the protection. (→ 98) If the disc or the contents on the disc have been protected on another device, release the protection on the same device.</li> <li>● (HD mode) Is the scene protected? → Release the protection. (→ 88) If the disc or the contents on the disc have been protected on another device, release the protection on the same device.</li> <li>● Scene which cannot be displayed as thumbnails (the thumbnails are displayed as [  ]) cannot be deleted. If the scenes are unnecessary, format the disc or SD card to erase the data. (→ 93, 94) Please be aware that if a disc or an SD card is formatted then all the data recorded on the disc or SD card will be erased.</li> <li>● Is the still picture file protected? → Protected files cannot be deleted. Release the protect setting. (→ 91)</li> <li>● If the SD card's write protect switch is set to LOCK, then deletion is disabled. (→ 29)</li> </ul>
The images on the SD card do not look normal.	<ul style="list-style-type: none"> <li>● The data may be destroyed. It may have been destroyed by static or electromagnetic waves. Store important data on a computer or other products as well.</li> </ul>

Problem	Check points
<p><b>Even if a disc or an SD card is formatted, it cannot be used.</b></p>	<ul style="list-style-type: none"> <li>• Either this unit or the disc or SD card may be damaged. Please consult a dealer. Use an SD card from 8 MB to 8 GB with this unit.</li> </ul>
<p><b>If the SD card is inserted in this unit, it is not recognized.</b></p>	<ul style="list-style-type: none"> <li>• Is the SD card formatted on a computer inserted? → Use this unit to format SD cards. Please be aware that if an SD card is formatted, then all the data recorded on the card will be erased. (→ 94)</li> </ul>
<p><b>If the SD card is inserted in another device, it is not recognized.</b></p>	<ul style="list-style-type: none"> <li>• Check that the device is compatible with the capacity or type of SD card (SD Memory Card/SDHC Memory Card) that you inserted. (→ 28) → Refer to the operating instructions of the device for details.</li> </ul>
<p><b>The indication disappears.</b></p> <p><b>The screen is frozen.</b></p> <p><b>No operation can be performed.</b></p>	<ul style="list-style-type: none"> <li>• Is this unit connected to a computer? → No operation can be performed on this unit when it is connected to a computer.</li> <li>• Turn off the power to this unit. If the power cannot be turned off, press the RESET button, or remove the battery or AC adaptor and then reattach it. After that, turn on the power again. If normal operation is still not restored, detach the power connected, and consult the dealer who you purchased this unit from.</li> </ul>
<p><b>White round spots like soap bubbles appear on the recorded picture.</b></p>	<ul style="list-style-type: none"> <li>• If you take a picture with the flash in a dark place or indoors, white round spots may appear on the picture caused by the flash reflecting of particles of dust in the air. This is not a malfunction.</li> </ul> <p>A characteristic of this is that the number of round spots and their position differ in every picture.</p> 



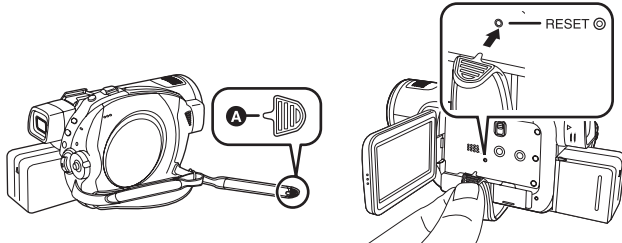

Problem	Check points
<p><b>“PUSH THE RESET SWITCH.” or “CHECK THE DISC AFTER PUSHING THE RESET SWITCH TO REPAIR THE DISC.” is displayed.</b></p>	<ul style="list-style-type: none"> <li>● Is the disc scratched or dirty? → After using the following method to restart the unit, eject the disc and clean it. (→ 30) If there are scratches on the disc, use a new disc.</li> <li>● The unit has automatically detected an error. Press the RESET button with the projecting part of the grip belt <b>A</b>. This will restart the unit.</li> </ul> <div style="text-align: center;">  </div> <ul style="list-style-type: none"> <li>● If you do not press the RESET button, the power to this unit is turned off automatically about 1 minute later.</li> <li>● Even after you press the RESET button, the indication may still appear repeatedly. If so, this unit needs repair. Detach the power connected, and consult the dealer who you purchased this unit from. Do not attempt to repair the unit by yourself.</li> </ul>

## ■ When connected to another device

Problem	Check points
<p><b>EZ Sync does not work.</b></p>	<ul style="list-style-type: none"> <li>● Are you connecting with the component cable or the AV cable? → Connect with a HDMI cable (optional). (→ 103)</li> <li>● Is the [EZ Sync] setting appropriate? → Press the MENU button, then select [SETUP] → [EZ Sync] → [ON] with the cursor button.</li> <li>● Depending on HDMI terminal of the TV, the input channel may not switch automatically. In this case, use the remote control for the TV to switch input. (For details on how to switch input, please read the operating instructions for the TV.)</li> <li>● Check the EZ Sync setting on the connected device.</li> <li>● Turn the power to the unit off and then back on again.</li> <li>● Set [EZ Sync] to [Off] on the TV and then turn it back to [On]. (Refer to the operating instructions of the TV for details.)</li> <li>● Are you using pictures recorded in STD mode? → Use pictures recorded in HD mode.</li> </ul>

**With a computer**

Problem	Check points
<p><b>Even if connected by the USB cable, this unit is not recognized by the computer.</b></p>	<ul style="list-style-type: none"> <li>● Is the AC adaptor connected? → Use the AC adaptor when connecting this unit and a computer.</li> <li>● Select another USB terminal on the computer.</li> <li>● Check the operating environment. (→ 115)</li> <li>● Turn the power to the unit off and then back on again and reconnect the USB cable.</li> </ul>
<p><b>When the USB cable is disconnected, an error message will appear on the computer.</b></p>	<ul style="list-style-type: none"> <li>● To disconnect the USB cable safely, double-click the  () icon in the task tray and follow the instructions on the screen.</li> </ul>
<p><b>Cannot see the PDF operating instructions for HD Writer 2.0E for SX/SD.</b></p>	<ul style="list-style-type: none"> <li>● Is Adobe Acrobat Reader 5.0 or later or Adobe Reader 7.0 or later installed on the computer that you are using? → You will need Adobe Acrobat Reader 5.0 or later or Adobe Reader 7.0 or later to read the PDF operating instructions for HD Writer 2.0E for SX/SD.</li> </ul>

## If scenes do not change smoothly when played back on another device

The images may be still for several seconds at the joins between the scenes if the following operations are performed when multiple scenes have been continuously played back using another unit.

\* Just how smoothly the scenes will be played back continuously depends on the playback unit.

Depending on the unit used, the images may stop moving and become still for a moment even when none of the following conditions are applicable.

### ■ When the scenes were recorded on different dates

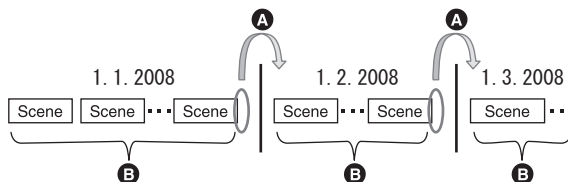

**A** The image will be still for several seconds wherever the date changes.

**B** The images are played back smoothly if the scenes were recorded on the same date.

### ■ When more than 99 scenes were recorded on the same date

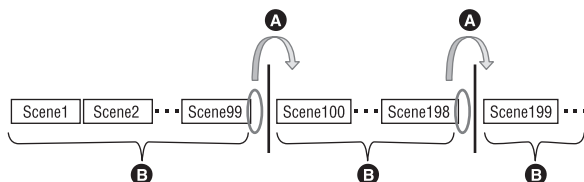

**A** The image will be still for several seconds when the scene changes every time 99 recorded scenes have been played back.

**B** The images of 99 consecutive scenes are played back smoothly.

### ■ When scenes lasting under 3 seconds have been recorded

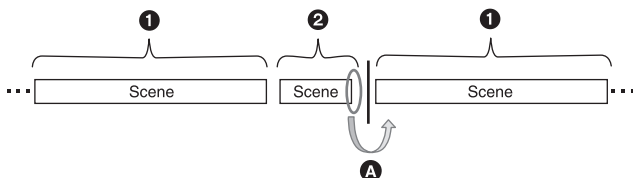

**1** 3 or more seconds

**2** Under 3 seconds

**A** The image will be still for several seconds after a scene which lasts under 3 seconds.

**When PRE-REC was used for recording**

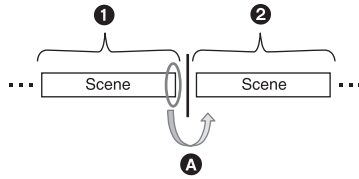

- 1 Normal recording
- 2 PRE-REC recording
- A The picture momentarily stops at the end of the last scene that was recorded normally before PRE-REC recording.

**When the recording mode was changed from HN/HE to HG or from HG to HN/HE**

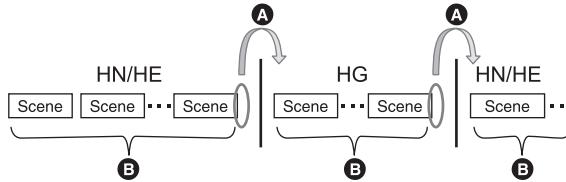

- A The picture momentarily stops where the scenes switch between HN/HE and HG modes.
- B Playback is smooth if the same mode is used or the mode is switched between HN and HE.

**When deleting scenes**

e.g. 1: Deleting scenes midway through a sequence of scenes.

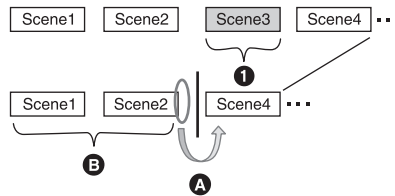

- 1 Scene to be deleted
- A The image will be still for several seconds wherever a scene was deleted.
- B The images of consecutive scenes where they are no deletions are played back smoothly one after another.

e.g. 2: When recording again after having deleted the last scene.

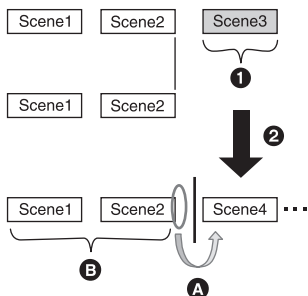

- ① Scene to be deleted
- ② A new scene is recorded here.
- Ⓐ The image will be still for several seconds wherever a scene was deleted.
- Ⓑ The images of consecutive scenes where there are no deletions are played back smoothly one after another.

## ■ When editing scenes on a computer using a program such as HD Writer 2.0E for SX/SD

e.g. 1: When scenes were selected using HD Writer 2.0E for SX/SD and output to the media



If scenes were dragged and dropped from the scene display area **A** and output to the media, the images will be still for several seconds wherever one scene changes to the next.

This stopping of the images for several seconds wherever one scene changes to the next can be prevented by dragging and dropping the scenes in the Image display area **B** or by clicking [Copy between media] button on the Start Menu.

**e.g. 2: When deleting scenes was initiated by HD Writer 2.0E for SX/SD**



When a scene is deleted, the images may be still for several seconds where that scene was deleted.

**e.g. 3: When merging scenes was initiated by HD Writer 2.0E for SX/SD**

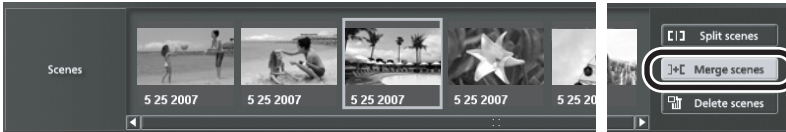

Wherever scenes are merged, the images may be still for several seconds where the original scenes were split.

## Cautions for use

### About this unit

- The unit, disc and SD card become warm after long operation, but this is not a malfunction.

**Keep the High Definition Video Camera as far away as possible from electromagnetic equipment (such as microwave ovens, TVs, video games etc.).**

- If you use the High Definition Video Camera on top of or near a TV, the pictures and sound on the High Definition Video Camera may be disrupted by electromagnetic wave radiation.
- Do not use the High Definition Video Camera near cell phones because doing so may result in noise adversely affecting the pictures and sound.
- Recorded data may be damaged, or pictures may be distorted, by strong magnetic fields created by speakers or large motors.
- Electromagnetic wave radiation generated by microprocessors may adversely affect the High Definition Video Camera, disturbing the pictures and sound.
- If the High Definition Video Camera is adversely affected by electromagnetic equipment and stops functioning properly, turn the High Definition Video Camera off and remove the battery or disconnect AC adaptor. Then reinsert the battery or reconnect AC adaptor and turn the High Definition Video Camera on.

**Do not use the High Definition Video Camera near radio transmitters or high-voltage lines.**

- If you record near radio transmitters or high-voltage lines, the recorded pictures and sound may be adversely affected.

**Make sure to use the supplied cords and cables. If you use optional accessories, use the cords and the cables supplied with them. Do not extend the cords and the cables.**

**Do not spray insecticides or volatile chemicals onto the unit.**

- If the unit is sprayed with such chemicals, its body may be marred and the surface finish may peel off.
- Do not leave rubber or plastic products in contact with the unit for a long time.

**When you use the unit in a sandy or dusty place such as a beach, do not let sand or fine dust get into the body and terminals of the unit.**

**Also, keep the unit away from sea water.**

- Sand or dust may damage the unit. (Care should be taken when inserting and removing a disc or a card.)
- If sea water splashes onto the unit, wipe off the water with a well wrung cloth. Then wipe the unit again with a dry cloth.

**When carrying the unit, do not drop or bump it.**

- A strong impact can break the unit's casing, causing it to malfunction.

**Do not use benzene, paint thinner or alcohol for cleaning the unit.**

- Before cleaning, detach the battery or pull out the AC cable from the AC outlet.
- The camera body may be discolored and the surface finish may peel off.
- Wipe the unit with a soft dry cloth to remove dust and fingerprints. To remove stubborn stains, thoroughly wring a cloth that has been soaked in a neutral detergent diluted with water and wipe the unit with it. Afterwards, wipe it with a dry cloth.
- When you use a chemical dust cloth, follow the instructions that came with the cloth.

**Do not touch the laser pickup lens.**

- If you touch the laser pickup lens directly it may cause malfunctions.

**Do not use the unit for surveillance purposes or other business uses.**

- This unit was designed for consumer intermittent use. It was not intended for continuous use, or for any industrial or commercial application resulting in prolonged use.

- In certain situations, continuous use could cause the unit to overheat and cause a malfunction. Such use is strongly discouraged.

### **When you are not going to use the unit for an extended time.**

- When storing the unit in a cupboard or cabinet, it is recommended that you place a desiccant (silica gel) in with it.

## About the battery

The battery used in this unit is a rechargeable lithium-ion battery. It is susceptible to humidity and temperature and the effect increases the more the temperature rises or falls. In cold areas, the full charge indication may not appear or the low battery indication may appear about 5 minutes after starting use. At high temperatures, the protection function may be triggered, making it impossible to use the unit.

### **Be sure to detach the battery after use.**

- If the battery is left attached, a minute amount of current continues to flow even if the unit's power is off. Keeping the unit in this state may result in over discharge of the battery. This may result in you not being able to use the battery even after it is charged.
- The battery should be stored in the vinyl bag so metal does not come into contact with the terminals.
- The battery should be stored in a cool place free from humidity, with as constant temperature as possible. (Recommended temperature: 15 °C to 25 °C (59 °F to 77 °F), Recommended humidity: 40% to 60%)
- Extremely high temperatures or low temperatures will shorten the life of the battery.
- If the battery is kept in high-temperature, high-humidity, or oily-smoky places, the terminals may rust and cause malfunctions.
- To store the battery for a long period of time, we recommend you charge it once every year and store it again after you have completely used up the charged capacity.
- Dust and other matter attached to the battery terminals should be removed.

### **Prepare spare batteries when going out for recording.**

- Prepare batteries enough to last for 3 to 4 times the period during you want to record pictures in. In cold places such as a ski resort, the period during which you can record pictures is shortened.
- When you travel, do not forget to bring an AC adaptor so that you can recharge the batteries at your destination.

### **If you drop the battery accidentally, check to see if the terminals are damaged.**

- Attaching a battery with damaged terminals can damage the unit or AC adaptor.

### **Do not throw old battery into fire.**

- Heating a battery or throwing it into a fire may result in an explosion.

### **If the operating time is very short even after the battery has been recharged, the battery has worn out. Please purchase a new battery.**

## About the AC adaptor

- If the temperature of the battery is extremely high or extremely low, charging may take time or the battery may not be charged.
- If the charging lamp keeps flashing, make sure that the terminals of the battery or the AC adaptor are not exposed to dirt, foreign objects or dust, then reconnect them properly. Disconnect the AC cable from the AC outlet when you remove dirt, foreign objects or dust on the terminals of the battery or the AC adaptor. If the charging lamp is still flashing, something may be wrong with the battery or AC adaptor. Contact your dealer.
- If you use the AC adaptor near a radio, radio reception may be disturbed. Keep the AC adaptor 1 m (3.3 feet) or more away from the radio.
- When using the AC adaptor, it may generate whirring sounds. However, this is normal.
- After use, be sure to disconnect the AC adaptor. (If it is left connected, a minute amount of current is consumed.)
- Always keep the electrodes of the AC adaptor and battery clean.

### **Put this unit near the outlet to make it easy for the interrupting device (plug) to reach it.**



## About the disc

### ● If there is dust, a scratch, or dirt on disc or if it is warped, the following phenomena may occur:

- Block noise in playback image
- Momentary stop of playback image
- Sound interrupted during playback, or abnormal sound
- [?] appears for thumbnail displays
- Disc cannot correctly be recognized
- Delay between video and audio

**When the ACCESS/PC lamp is illuminated (during access to the disc), do not open the disc cover, turn off the power, or cause any vibrations or impacts.**



### DVD-R/DVD-R DL

- For optimum recording on DVD-R or DVD-R DL discs, this unit writes control data to a DVD-R or DVD-R DL used for recording when it is being inserted and ejected. If the disc has no area for control data to be written, recording may not be possible. To prevent this, do not insert a DVD-R or DVD-R DL which has been recorded on more than 50 times.
- Do not insert a DVD-R or DVD-R DL recorded on this unit that has not been finalized into a recordable device, such as a DVD recorder. The recorded data may be damaged.

## About the SD card

- The memory capacity indicated on the label of an SD card is the total of the capacity for copyright protection and management and the capacity which can be used on the unit, a computer etc.
- During prolonged use, the unit's surfaces and the SD card will heat up slightly. This is normal.

**Always set the mode dial to OFF when inserting or removing an SD card.**

**While this unit accesses the SD card (while  or  is being displayed/the access lamp is lit), do not remove the SD card, operate the mode dial, turn off the power or shake or impact the unit.**

## About the miniSD Card

- Be sure to insert miniSD Cards in the dedicated card adaptor before use. Inserting a card in this unit without the adaptor may damage the unit or the card.
- Do not insert an empty card adaptor in this unit. Do not leave the adaptor in this unit while inserting or removing miniSD Cards. This may cause the unit to malfunction.

## LCD monitor/viewfinder

- When the LCD monitor gets dirty, wipe it with a dry soft cloth.
- In a place with drastic temperature changes, condensation may form on the LCD monitor. Wipe it with soft dry cloth.
- When the unit has become very cold, for example due to storage in a cold area, its LCD monitor will be slightly darker than usual immediately after the power is turned on. The normal brightness will be restored when the unit's internal temperature rises.

Extremely high precision technology is employed to produce the LCD Monitor screen featuring a total of approximately 300,000 pixels. The result is more than 99.99% effective pixels with a mere 0.01% of the pixels inactive or always lit. However, this is not a malfunction and does not affect the recorded picture.

Extremely high precision technology is employed to produce the viewfinder screen featuring a total of approximately 183,000 pixels. The result is more than 99.99% effective pixels with a mere 0.01% of the pixels inactive or always lit. However, this is not a malfunction and does not affect the recorded picture.

## About condensation

When condensation forms on the unit, the lens will cloud up and the unit may not work properly. Make every effort to ensure that condensation does not form. If it does form, take the actions described below.

### Causes of condensation

**Condensation takes place when the ambient temperature or humidity is changed as follows.**

- When this unit is brought inside from the cold (e.g. a ski slope) to a warm room.
- When this unit is moved from an air-conditioned car to outside.
- When a cold room has been warmed up quickly.
- When cool wind from an air conditioner is directly blown onto this unit.
- After summer afternoon showers of rain.
- When this unit is in a very humid place where the air is thick with steam. (e.g. a heated swimming pool)

**When this unit is taken to a location with a significant temperature difference such as from a cold place to a hot place.**

If, for example, you have used this unit for recording on a ski slope and are taking it into a heated room, place the unit inside a plastic bag, remove as much of the air from inside the bag as possible, then seal the bag. Leave the unit for about an hour in the room so the temperature of the unit is close to the ambient temperature of the room, then use it.

### What to do with the lens is fogged up.

Remove the battery or AC adaptor and leave the unit for about 1 hour. When the unit becomes close to the ambient temperature, the fog disappears naturally.

## Explanation of terms

### Automatic white balance

White balance adjustment recognizes the color of light and adjusts so the white color will become a purer white. The unit determines the hue of light that comes through the lens and white balance sensor, thereby judging the recording condition, and selects the closest hue setting.

This is called automatic white balance adjustment.

However, since the unit only stores white color information under several light sources, automatic white balance adjustment does not function normally under other light sources.

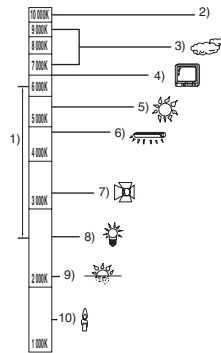

The illustration above shows the range over which the auto white balance functions.

- 1) The effective range of automatic white balance adjustment on this unit
- 2) Blue sky
- 3) Cloudy sky (rain)
- 4) TV screen
- 5) Sunlight
- 6) White fluorescent lamp
- 7) Halogen light bulb
- 8) Incandescent light bulb
- 9) Sunrise or sunset
- 10) Candlelight

Outside of the effective range of automatic white balance adjustment, the image will become reddish or bluish. Even within the effective range of automatic white balance adjustment, the automatic white balance adjustment may not function properly if there is more than one light source. For light outside the functional automatic white balance adjustment range, use the manual white balance adjustment mode.

### **White balance**

The images recorded by the unit may become bluish or reddish under the influence of certain light sources. To avoid such phenomena, adjust the white balance.

White balance adjustment determines the white color under different light sources. By recognizing which is the white color under sunlight and which is the white color under a fluorescent light, the unit can adjust the balance among the other colors.

Since the white color is the reference for all the colors (that make up light), the unit can record pictures in a natural hue if it can recognize the reference color white.

### **Auto focus**

The lens is moved forward or backward automatically to bring the subject into focus.

**Auto focus has the following characteristics.**

- **Adjusts so that the vertical lines of a subject are seen more clearly.**
- **Attempts to bring an object with higher contrast into focus.**
- **Focuses on the screen center only.**

Due to these characteristics, auto focus does not work correctly in the following situations. Record pictures in the manual focus mode.

#### ● **Recording distant and close-up objects at the same time**

Since the unit focuses on whatever is at the center of the screen, it is difficult to bring the background into focus when close-up objects are placed in focus. When recording people with distant mountains in the background, you cannot focus on both the subject which is close-up and the objects which are in the distance.

#### ● **Recording a subject behind dirty or dusty window**

The subject behind the window will not be focused because the focus is on the dirty window.

Similarly, when recording something on the opposite side of a road with heavy traffic, a vehicle that happens to pass by may be brought into focus.

#### ● **Recording a subject that is surrounded by objects with glossy surfaces or by highly reflective objects**

Since whatever is shiny or glistens is brought into focus, it is hard to focus on the subject to be recorded. The focus may become blurry when recording subjects at the beach, in night views or in scenes involving fireworks or special lights.

#### ● **Recording a subject in dark surroundings**

The unit cannot focus correctly because the light information that comes through the lens decreases considerably.

#### ● **Recording a fast-moving subject**

As the focus lens-inside moves mechanically, it cannot keep up with a fast-moving subject. When, for example, recording a sports event with fast moving subjects, the focus may lose its sharpness.

#### ● **Recording a subject with little contrast**

It is easy to bring subjects with a sharp contrast or vertical lines or stripes into focus. This means that a subject with little contrast, such as a white wall, may become blurry because the unit achieves focus based upon the vertical lines of an image.

## Specifications

### High Definition Video Camera

Information for your safety

<b>Power source:</b>	DC 9.3 V (When using AC adaptor)/7.2 V (When using battery)
<b>Power consumption:</b>	Recording 10.2 W

<b>Signal system</b>	<b>HD mode:</b> 1080/60i <b>STD mode:</b> 525/60i
<b>Recording format</b>	<b>HD mode:</b> Motion picture: AVCHD format compliant Still picture: JPEG <b>STD mode:</b> Motion picture: DVD Video Recording format (DVD-RAM, DVD-RW) DVD-Video format (DVD-RW, DVD-R, DVD-R DL)
<b>Image sensor</b>	1/6" 3CCD image sensor Total: 560 K×3 Effective pixels: Motion picture/still picture: 520 K×3
<b>Lens</b>	Auto Iris, F1.8 to F2.8 Focal length: 3.0 mm to 30.0 mm Macro (Full range AF)
<b>Filter diameter</b>	37 mm
<b>Zoom</b>	10× optical zoom, 25/700× digital zoom
<b>Monitor</b>	2.7" wide LCD monitor (approx. 300 K pixels)
<b>Viewfinder</b>	0.44" wide EVF (approx. 183 K pixels)
<b>Microphone</b>	Stereo (with a zoom function)
<b>Speaker</b>	1 round speaker ∅ 20 mm
<b>White balance adjustment</b>	Auto tracking white balance system
<b>Standard illumination</b>	1,400 lx
<b>Minimum required illumination</b>	Approx. 5 lx (Low light mode: 1/30) Approx. 1 lx (MagicPix mode)
<b>Video output level</b>	1.0 Vp-p, 75 Ω
<b>Component terminal output level</b>	Y: 1.0 Vp-p, 75 Ω Pb: 0.7 Vp-p, 75 Ω Pr: 0.7 Vp-p, 75 Ω 1125i (1080i)/525i (480i)
<b>HDMI terminal output level</b>	HDMI 1125i (1080i)/525p (480p)
<b>Audio output level (Line)</b>	316 mV, 600 Ω

<b>USB</b>	Card reader/writer function (No copyright protection support) Hi-Speed USB (USB 2.0), USB terminal Type miniB PictBridge-compliant
<b>Flash</b>	Available range: Approx. 1 m to 2.5 m (3.3 feet to 8.2 feet)
<b>Dimensions</b>	83.5 mm (W)×93.5 mm (H)×151.5 mm (D) [3.30" (W)×3.70" (H)×6.00" (D)] (excluding projecting parts)
<b>Mass (Weight)</b>	Approx. 540 g (1.20 lbs.) (without supplied battery, disc and an SD card)
<b>Mass (Weight) in operation</b>	Approx. 660 g (1.46 lbs.) (with supplied battery, disc and an SD card)
<b>Operating temperature</b>	0 °C to 40 °C (32 °F to 104 °F) (0 °C to 30 °C (32 °F to 86 °F) when connected to the computer)
<b>Operating humidity</b>	10% to 80%
<b>Battery operation time</b>	See page 32

### Motion pictures

<b>Recording media</b>	<b>Disc:</b> 8 cm (3") DVD-RAM Ver. 2.1 8 cm (3") DVD-RW Ver. 1.1/2X-SPEED (2X/1X) 8 cm (3") DVD-R for General Ver. 2.0 8 cm (3") DVD-R for DL Ver. 3.0 <b>SD Memory Card:</b> 256 MB, 512 MB, 1 GB, 2 GB (FAT12 and FAT16 system compliant) <b>SDHC Memory Card:</b> 4 GB, 8 GB (FAT32 system compliant)
<b>Compression</b>	<b>HD mode:</b> MPEG-4 AVC/H.264 <b>STD mode:</b> MPEG2
<b>Recording mode and transfer rate</b>	<b>HD mode:</b> HG: Approx. 13 Mbps (CBR) (Approx. 14 min recordable time on a single-sided DVD-RAM) HN: Approx. 9 Mbps (VBR) (Approx. 21 min recordable time on a single-sided DVD-RAM) HE: Approx. 6 Mbps (VBR) (Approx. 31 min recordable time on a single-sided DVD-RAM) <b>STD mode:</b> XP: 10 Mbps (VBR) (Approx. 18 min recordable time on a single-sided DVD-RAM) SP: 5 Mbps (VBR) (Approx. 37 min recordable time on a single-sided DVD-RAM) LP: 2.5 Mbps (VBR) (Approx. 75 min recordable time on a single-sided DVD-RAM)
<b>Picture size</b>	HG: 1920×1080 HN/HE: 1440×1080

## Others

<b>Audio compression</b>	Dolby Digital (Dolby AC3)/2 ch
--------------------------	--------------------------------

## Still pictures

<b>Recording media</b>	<b>SD Memory Card:</b> 8 MB/16 MB/32 MB/64 MB/128 MB/256 MB/512 MB/1 GB/2 GB (FAT12 and FAT16 format corresponding) <b>SDHC Memory Card:</b> 4 GB, 8 GB (FAT32 format corresponding)
<b>Compression</b>	JPEG (Design rule for Camera File system, based on Exif 2.2 standard), DPOF corresponding
<b>Picture size</b>	1920×1080

## AC adaptor

Information for your safety

<b>Power source:</b>	AC 110 V to 240 V, 50/60 Hz
<b>Power consumption:</b>	19 W
<b>DC output:</b>	DC 9.3 V, 1.2 A (Unit operation) DC 8.4 V, 0.75 A (Battery charging)

<b>Dimensions</b>	92 mm (W)×33 mm (H)×61 mm (D) [3.6" (W)×1.3" (H)×2.4" (D)]
<b>Mass (Weight)</b>	Approx. 115 g (0.25 lbs.)













## Battery pack



Information for your safety

<b>Maximum voltage:</b>	DC 8.4 V
<b>Nominal voltage:</b>	DC 7.2 V
<b>Rated capacitance:</b>	2640 mAh

Specifications may change without prior notice.

## Optional accessories

Accessory No.	Figure	Description
LM-AF30U		8 cm (3") DVD-RAM (single sided)
LM-AF60U		8 cm (3") DVD-RAM (double sided)
LM-RW30U		8 cm (3") DVD-RW (single sided)
LM-RW60U		8 cm (3") DVD-RW (double sided)
LM-RF30V		8 cm (3") DVD-R (single sided)
LM-RF60V		8 cm (3") DVD-R (double sided)
LM-RF55LV		8 cm (3") DVD-R DL (dual layer on single side)
VW-AD21PP-K		AC adaptor with AC Cable and DC Cables
VW-VBG260*1		2640 mAh/Rechargeable Lithium Ion Battery Pack
VW-VBG130*1		1320 mAh/Rechargeable Lithium Ion Battery Pack
VW-VBG6*1*2		5800 mAh/Rechargeable Lithium Ion Battery Pack
VW-VH04		Battery Pack Holder Kit
VW-LDH3		Video DC Light (3 W)
VW-FLH3		Video Flash
VW-VMH3		Stereo Zoom Microphone

Accessory No.	Figure	Description
VW-T3714H		Tele Conversion Lens
VW-W3707H		Wide Conversion Lens
RP-SDR01GU1A RP-SDR512U1A		Class 2 1 GB SD Memory Card Class 2 512 MB SD Memory Card
RP-SDM04GU1K RP-SDM02GU1A		Class 4 4 GB SDHC Memory Card Class 4 2 GB SD Memory Card
RP-SDV08GU1K RP-SDV08GU1A (USA only) RP-SDV04GU1K RP-SDV02GU1A RP-SDV01GU1A		Class 6 8 GB SDHC Memory Card Class 6 4 GB SDHC Memory Card Class 6 2 GB SD Memory Card Class 6 1 GB SD Memory Card

\*1 Please refer to page 32 concerning the battery charging time and available recording time.

\*2 The battery pack holder kit VW-VH04 (optional) is necessary.

**NOTE:**

**Accessories and/or model numbers may vary by country. Please consult your local dealer.**



## Accessory Order Form (For USA Customers)

Please photocopy this form when placing an order.

1. Model # \_\_\_\_\_

2. Items Ordered

Accessory #	Description	Price Each	Quantity	Total Price
Subtotal				
Your State & Local Sales Tax				
Shipping & Handling				6.95
Total Enclosed				

3. Method of payment (check one)

- Check of Money Order enclosed (NO C.O.D.SHIPMENTS)
- VISA                      Credit Card # \_\_\_\_\_
- MasterCard              Expiration Date \_\_\_\_\_
- Discover                    Customer Signature \_\_\_\_\_

Make Check or Money Order Payable to: PANASONIC ACCESSORIES

(Please do not send cash)

4. Shipping information (UPS delivery requires complete street address)

Ship To:

Mr.

Mrs.

Ms.

\_\_\_\_\_

First

Last

Phone#:

Day ( ) \_\_\_\_\_

\_\_\_\_\_

Street Address

Night ( ) \_\_\_\_\_

\_\_\_\_\_

City

State

Zip

TO OBTAIN ANY OF OUR ACCESSORIES YOU CAN DO ANY OF  
THE FOLLOWING:  
VISIT YOUR LOCAL PANASONIC DEALER  
OR  
CALL PANASONIC'S ACCESSORY ORDER LINE AT 1-800-332-5368  
[6 AM-6 PM M-F, PACIFIC TIME]  
OR  
MAIL THIS ORDER TO: PANASONIC SERVICE AND TECHNOLOGY COMPANY ACCESSORY ORDER OFFICE  
20421 84th Avenue South Kent, WA. 98032

In CANADA, please contact your local Panasonic dealer for more information on Accessories.

***Request for Service Notice*** (USA Only)

---

Please photocopy this form when making a request for service notice, in the unlikely event this product needs service.

**Request for Service Notice:**

- Please include your **proof of purchase.**  
(Failure to do so will delay your repair.)
  - To further speed your repair, please provide an explanation of what is wrong with the unit and any symptom it is exhibiting.
- 
- 
- 
- 

Mail this completed form and your Proof of Purchase along with your unit to:  
Panasonic Camera and Digital Service Center  
1590 Touhy Ave.  
Elk Grove Village, IL 60007

## Limited Warranty (For USA Customers)

PANASONIC CONSUMER ELECTRONICS  
COMPANY, DIVISION OF PANASONIC  
CORPORATION OF NORTH AMERICA  
One Panasonic Way, Secaucus, New Jersey 07094

PANASONIC PUERTO RICO, INC.  
Ave. 65 de Infantería, Km. 9.5 San Gabriel Industrial Park,  
Carolina, Puerto Rico 00985

### Panasonic Video Products Limited Warranty

#### Limited Warranty Coverage

If your product does not work properly because of a defect in materials or workmanship, Panasonic Consumer Electronics Company or Panasonic Puerto Rico, Inc. (collectively referred to as "the warrantor") will, for the length of the period indicated on the chart below, which starts with the date of original purchase ("warranty period"), at its option either (a) repair your product with new or refurbished parts, or (b) replace it with a new or a refurbished product. The decision to repair or replace will be made by the warrantor.

Product	Parts	Labor	Service	Contact Number
Camcorder	One (1) Year (except CCD Image Sensor) CCD Image Sensor - 6 (Six) Months	Ninety (90) Days Ninety (90) Days	Carry-In or Mail-In	1-800-211-PANA(7262)
DVD/VCR Deck, A/V Mixer	One (1) Year	Ninety (90) Days	Carry-In or Mail-In	1-800-211-PANA(7262)
TV/VCR, TV/DVD, TV/DVD/VCR Combination	One (1) Year (except CRT) CRT - Two (2) Years	Ninety (90) Days Ninety (90) Days	Carry-In: 21" CRT and Smaller In-Home or Carry-In: 22" CRT and Larger	1-800-211-PANA(7262)
TV/HDR Combination	One (1) Year (except CRT) CRT - Two (2) Years	Ninety (90) Days Ninety (90) Days	In-Home or Carry-In	1-888-843-9788
Rechargeable Batteries (in exchange for defective item)	Ten (10) Days	Not Applicable	Carry-In or Mail-In	1-800-211-PANA(7262)
Tape (in exchange for defective item)	Five (5) Days	Not Applicable	Carry-In or Mail-In	1-800-211-PANA(7262)
Memory Cards (in exchange for defective item)	Ninety (90) Days	Not Applicable	Carry-In or Mail-In	1-800-211-PANA(7262)

During the "Labor" warranty period there will be no charge for labor. During the "Parts" warranty period, there will be no charge for parts. You must carry-in or mail-in (prepaid) your product or arrange for in-home service, as applicable, during the warranty period.

If non-rechargeable batteries are included, they are not warranted. This warranty only applies to products purchased and serviced in the United States or Puerto Rico. This warranty is extended only to the original purchaser of a new product which was not sold "as is". A purchase receipt or other proof of the original purchase date is required for warranty service.

#### Carry-In, Mail-in (Prepaid) or In-Home Service

For Carry-In, Mail-In (prepaid) or In-Home Service (as applicable) in the United States call toll free contact number listed above or visit Panasonic Web Site: <http://www.panasonic.com>

For assistance in Puerto Rico call Panasonic Puerto Rico, Inc. (787)-750-4300 or fax (787)-768-2910.

In-Home service, if applicable, requires clear, complete and easy access to the product by the authorized servicer and does not include removal or re-installation of an installed product. It is possible that certain in-home repairs will not be completed in-home, but will require that the product, or parts of the product, be removed for shop diagnosis and/or repair and then returned.

#### Limited Warranty Limits And Exclusions

This warranty ONLY COVERS failures due to defects in materials or workmanship, and DOES NOT COVER normal wear and tear or cosmetic damage, nor does it cover markings or retained images on the picture tube resulting from viewing fixed images (including, among other things, letterbox pictures on standard 4:3 screen TV's, or non-expanded standard 4:3 pictures on wide screen TV's, or onscreen data in a stationary and fixed location). The warranty ALSO DOES NOT COVER damages which occurred in shipment, or failures which are caused by products not supplied by the warrantor, or failures which result from accidents, misuse, abuse, neglect, bug infestation, mishandling, misapplication, alteration, faulty installation, set-up adjustments, misadjustment of consumer controls, improper maintenance, power line surge, lightning damage, modification, or commercial use (such as in a hotel, office, restaurant, or other business), rental use of the product, service by anyone other than a Factory Service Center or other Authorized Servicer, or damage that is attributable to acts of God.

**THERE ARE NO EXPRESS WARRANTIES EXCEPT AS LISTED UNDER "LIMITED WARRANTY COVERAGE". THE WARRANTOR IS NOT LIABLE FOR INCIDENTAL OR CONSEQUENTIAL DAMAGES RESULTING FROM THE USE OF THIS PRODUCT, OR ARISING OUT OF ANY BREACH OF THIS WARRANTY.**

(As examples, this excludes damages for lost time, cost of having someone remove or re-install an installed unit if applicable, or travel to and from the servicer, loss of media or images, data or other memory or recorded content. The items listed are not exclusive, but are for illustration only.)

**ALL EXPRESS AND IMPLIED WARRANTIES, INCLUDING THE WARRANTY OF MERCHANTABILITY, ARE LIMITED TO THE PERIOD OF THE LIMITED WARRANTY.**

Some states do not allow the exclusion or limitation of incidental or consequential damages, or limitations on how long an implied warranty lasts, so the exclusions may not apply to you. This warranty gives you specific legal rights and you may also have other rights which vary from state to state. If a problem with this product develops during or after the warranty period, you may contact your dealer or Service Center. If the problem is not handled to your satisfaction, then write to the warrantor's Consumer Affairs Department at the addresses listed for the warrantor.

**PARTS AND SERVICE (INCLUDING COST OF AN IN-HOME SERVICE CALL, WHERE APPLICABLE) WHICH ARE NOT COVERED BY THIS LIMITED WARRANTY ARE YOUR RESPONSIBILITY.**

---

## Customer Services Directory

---

Service in Canada: As per Sevicercenter listed in Canadian warranty information → 165.

Obtain Product Information and Operating Assistance; locate your nearest Dealer or Service Center; purchase Parts and Accessories; or make Customer Service and Literature requests by visiting our Web Site at:

<http://www.panasonic.com/consumersupport>

or, contact us via the web at:

<http://www.panasonic.com/contactinfo>

You may also contact us directly at:

1-800-211-PANA (7262),

Monday-Friday 9 am-9 pm; Saturday-Sunday 10 am-7 pm, EST

For hearing or speech impaired TTY users, TTY : 1-877-833-8855

### Accessory Purchases

Purchase Parts, Accessories and Instruction Books online for all Panasonic Products by visiting our Web Site at:

<http://www.pstc.panasonic.com>

or, send your request by E-mail to:

[npcparts@us.panasonic.com](mailto:npcparts@us.panasonic.com)

You may also contact us directly at:

1-800-332-5368 (Phone) 1-800-237-9080 (Fax Only) (Monday – Friday 9 am to 9 pm, EST.)

Panasonic Service and Technology Company

20421 84th Avenue South,

Kent, WA 98032

(We Accept Visa, MasterCard, Discover Card, American Express, and Personal Checks)

For hearing or speech impaired TTY users, TTY : 1-866-605-1277

### Product Repairs

### Centralized Factory Service Center

MAIL TO:

Panasonic Camera and Digital Service Center

1590 Touhy Ave.

Elk Grove Village, IL 60007

Please carefully pack and ship, prepaid and insured, to the Elk Grove Village Centralized Factory Service Center.

Customer's in Puerto Rico, please ship or carry in to location below ("Service in Puerto Rico").

### Service in Puerto Rico

*Panasonic Puerto Rico, Inc.*

*Ave. 65 de Infantería, Km. 9.5, San Gabriel Industrial Park,*

*Carolina, Puerto Rico 00985*

*Phone (787)750-4300, Fax (787)768-2910*

As of January 2007

---

**Warranty** (For Canadian Customers)

---

**Panasonic Canada Inc.**

5770 Ambler Drive, Mississauga, Ontario L4W 2T3

**PANASONIC PRODUCT – LIMITED WARRANTY**

Panasonic Canada Inc. warrants this product to be free from defects in material and workmanship and agrees to remedy any such defect for a period as stated below from the date of original purchase.

**Camcorder Product – One (1) year, parts and labour****LIMITATIONS AND EXCLUSIONS**

This warranty does not apply to products purchased outside Canada or to any product which has been improperly installed, subjected to usage for which the product was not designed, misused or abused, damaged during shipping, or which has been altered or repaired in any way that affects the reliability or detracts from the performance, nor does it cover any product which is used commercially. Dry cell batteries are also excluded from coverage under this warranty.

This warranty is extended to the original end user purchaser only. A purchase receipt or other proof of date of original purchase is required before warranty service is performed.

**THIS EXPRESS, LIMITED WARRANTY IS IN LIEU OF ALL OTHER WARRANTIES, EXPRESS OR IMPLIED, INCLUDING ANY IMPLIED WARRANTIES OF MERCHANTABILITY AND FITNESS FOR A PARTICULAR PURPOSE.**

**IN NO EVENT WILL PANASONIC CANADA INC. BE LIABLE FOR ANY SPECIAL, INDIRECT OR CONSEQUENTIAL DAMAGES.**

In certain instances, some jurisdictions do not allow the exclusion or limitation of incidental or consequential damages, or the exclusion of implied warranties, so the above limitations and exclusions may not be applicable.

**WARRANTY SERVICE**

**FOR PRODUCT OPERATION ASSISTANCE**, please contact:

Our Customer Care Centre: Telephone #: (905) 624-5505  
1-800 #: 1-800-561-5505  
Fax #: (905) 238-2360  
Email link: "Customer support" on [www.panasonic.ca](http://www.panasonic.ca)

**FOR PRODUCT REPAIRS**, please locate your nearest Authorized Servicentre at [www.panasonic.ca](http://www.panasonic.ca) :

Link: "Servicentres™ locator" under "Customer support"

**IF YOU SHIP THE PRODUCT TO A SERVICENTRE**

Carefully pack and send prepaid, adequately insured and preferably in the original carton.

Include details of the defect claimed, and proof of date of original purchase.

## Index

### ■ A

A/V terminal	19, 105, 106
AC adaptor	31, 35, 152
Accessory shoe	21
Aperture	77
Auto focus	155
Auto Ground-directional Standby (AGS)	52
Auto protect	98
Auto slow shutter	73
Automatic white balance	76, 154
AVCHD	14

### ■ B

Backlight compensation	66
Battery	31, 32, 152
Beep sound	132
Black balance	77

### ■ C

Card	28, 30, 40, 153
Charging time	32
Color bar	73
Component terminal	105
Cooling fan	19
Copy	89
Creating a top menu	96
Cursor button	41

### ■ D

Date and time display	49
Date and time setting	48
Delete scene	86
Delete still picture	90
Demo mode	132
Digital zoom	62
Disc	24, 30, 39, 153
Disc information	99
Display	131
Dividing a scene to delete	87
DPOF setting	92
Dubbing	109
DVD-RAM, DVD-RW, DVD-R, DVD-R DL	24, 25

### ■ E

EZ Sync	103
---------	-----

### ■ F

Fade	64
Finalize	94
Flash	67
Focus	58, 75
Format card	94
Format disc	93
Frame-by-frame playback	82

### ■ G

Gain	78
Grip belt	19
Guide line	70

### ■ H

HDMI terminal	101, 103
Help mode	46
High definition	14

### ■ I

Image stabilizer function	69
Initial setting	132
Intelligent contrast control	63
Iris	78

### ■ L

Language	46
LCD monitor	21, 49, 153
Lens hood	20

### ■ M

MagicPix function	65
Manual focus	75
Menu	47
Menu list	128
MF assist	75
Microphone level	71
Microphone on the accessory shoe	131
Mode dial	36
Motion picture playback	79
Motion picture recording	53

### ■ N

Number of recordable pictures	61
-------------------------------	----

### ■ O

Operation icons	43
-----------------	----

<b>■ P</b>		<b>■ U</b>	
Pickup lens	39	Un-finalize	96
PictBridge	110	<b>■ V</b>	
Picture quality	60	Video format	26
Playing back motion pictures by date	83	Viewfinder	22, 49, 153
POWER LCD EXTRA	50	Volume adjustment	83
Power save	131	VR format	26
PRE-REC	55	<b>■ W</b>	
Protect (Disc)	97, 98	White balance	76, 155
Protecting scenes	88	Wind noise reduction function	71
Protecting still pictures	91	<b>■ Z</b>	
<b>■ Q</b>		Zebra	72
Quick start	38	Zoom	61
<b>■ R</b>		Zoom microphone	62
Recordable time	33		
Recordable time available			
for the motion picture	56		
Recording lamp	131		
Recording modes available			
for the motion picture	56		
Recording time elapsed	53		
Red eye reduction	68		
Remaining battery capacity indication	35		
Remaining number of still pictures	59		
Remaining time	53		
Remote control	22		
Repair	137		
Repeat playback	80		
Request for Service Notice (USA Only)	162		
Resume playback	83		
<b>■ S</b>			
Scene mode	74		
SD Memory Card	28		
SDHC Memory Card	28		
Self-recording	63		
Self-timer recording	66		
Shutter sound	59		
Shutter speed	77		
Simultaneous recording	60		
Skip playback	81		
Slide show	84		
Slow-motion playback	82		
Soft skin mode	65		
Still picture compatibility	84		
Still picture playback	84		
Still picture recording	58		
<b>■ T</b>			
Tele macro	69		
Tripod receptacle	21		
TV aspect	107		

## Spanish Quick Use Guide/ Guía española para el uso rápido

### ■ Carga de la batería

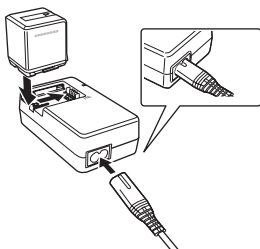

- 1 Conecte el cable de CA al adaptador de CA y a la toma de CA.
- 2 Instale la batería en el compartimiento alineando la marca y, luego, conéctela de forma segura.

### ■ Instalación de la batería

Empuje la batería contra el compartimiento de la batería y deslicela hasta escuchar un clic.

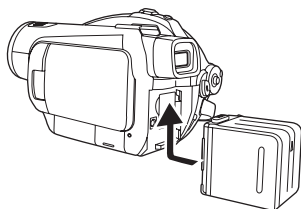

### ■ Extracción de la batería

Mientras desliza la palanca BATTERY, deslice la batería para extraerla.

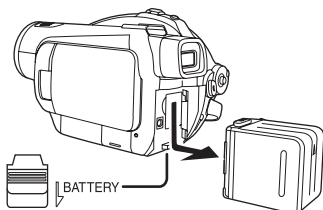

### ■ Cómo encender la cámara

Mientras pulsa el botón de desbloqueo **A**, ajuste el disco del modo a **□**, **●** o a **▶**.

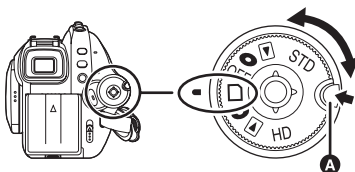

### ■ Cómo apagar la cámara

Ajuste el disco del modo a OFF.

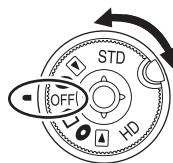



## ■ Insertar/extraer un disco

- 1 Unir la batería o conectar el adaptador de CA.
- 2 Deslice la palanca DISC EJECT una vez y luego suéltela.

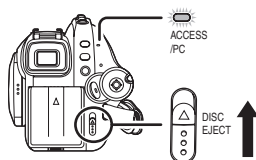

- 3 Abra la tapa del compartimento del disco con la mano e inserte/extraiga el disco.

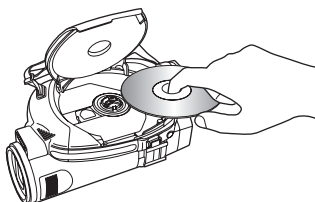

- 4 Presione la sección de la tapa del compartimento del disco marcada PUSH CLOSE para cerrar la tapa.

## ■ Insertar/extraer una tarjeta SD

- 1 Ajuste el disco del modo a OFF.
- 2 Abra el monitor LCD e inserte/extraiga la tarjeta SD en/de la ranura de la tarjeta.

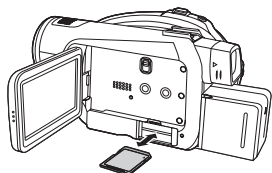

## ■ Grabación de imágenes en movimientos

- 1 Gire el disco del modo para seleccionar  o a .

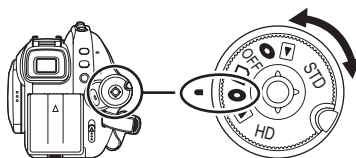

- 2 Pulse el botón de inicio/parada de grabación para iniciar la grabación.

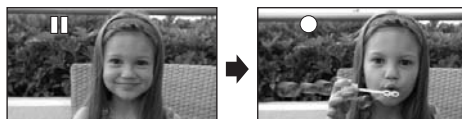

- 3 Vuelva a pulsar el botón de inicio/parada de grabación para hacer una pausa en la grabación.

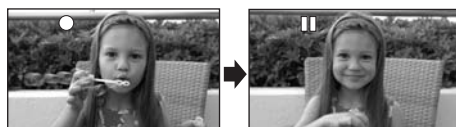

■ Utilice una tarjeta SD para grabar imágenes fijas (Imágenes JPEG)

- 1 Gire el disco del modo para seleccionar  .

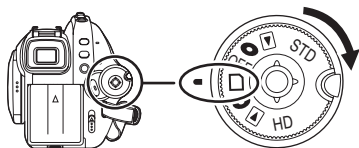

- 2 Pulse el botón PHOTO SHOT hasta la mitad para ajustar el enfoque. (Sólo para enfoque automático)

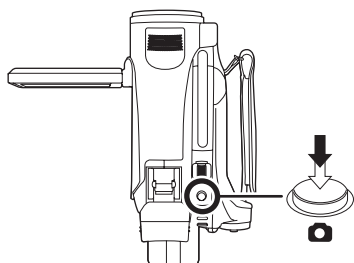

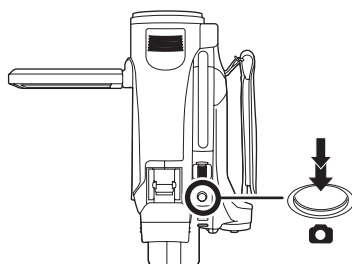

- 3 Pulse el botón PHOTO SHOT a tope para tomar la imagen.

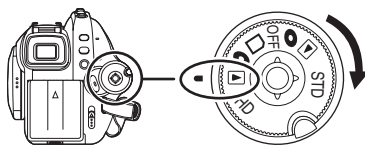

■ Reproducción de imágenes en movimiento

- 1 Gire el disco del modo para seleccionar  .



- 2 (Sólo modo HD) Pulse el cursor hacia arriba y luego seleccione la ficha  o  .

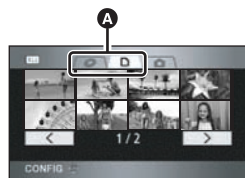





- A** Ficha de reproducción de imágenes en movimiento

- 3 Seleccione la escena que desea reproducir.

- 4 Pulse el botón cursor.





- 5 Mueva el botón cursor para obrar.

- 
- : Reproducción/pausa
  - : Revisión
  - : Localización
  - : Detener la reproducción y visualizar las miniaturas.
-

## ■ Reproducción de imágenes fijas (Imágenes JPEG) en una tarjeta SD

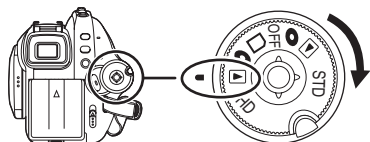
- 1 Gire el disco del modo para seleccionar  .



- 2 Pulse el cursor hacia arriba y luego hacia la derecha para seleccionar la ficha  .



- A** Ficha de reproducción de imágenes fija

- 3 Seleccione el archivo que desea reproducir.

- 4 Pulse el botón cursor.



- 5 Mueva el botón cursor para obrar.

- 
- ▶/||: Iniciar o hacer una pausa en la presentación de diapositivas (reproducción de las imágenes fijas contenidas en la tarjeta SD en orden numérico).
  - ◀: Reproducir la imagen anterior.
  - ▶: Reproducir la imagen siguiente.
  - : Detener la reproducción y visualizar las miniaturas.
-

**Panasonic Consumer Electronics Company,  
Division of Panasonic Corporation of North America**

One Panasonic Way, Secaucus, NJ 07094

**Panasonic Puerto Rico, Inc.**

Ave. 65 de Infantería, Km. 9.5, San Gabriel Industrial Park, Carolina, Puerto Rico 00985

**Panasonic Canada Inc.**

5770 Ambler Drive, Mississauga, Ontario, L4W 2T3



VQT1J42

F0707MK0 ( 3500 (A) )

C

